



Faculty of Science and Technology
Department of Safety and Engineering

Icing Effects on Power Lines and Anti-icing and De-icing Methods

—

Ali Raza Solangi

TEK-3901-Master's thesis in Technology and Safety in High North- June 2018

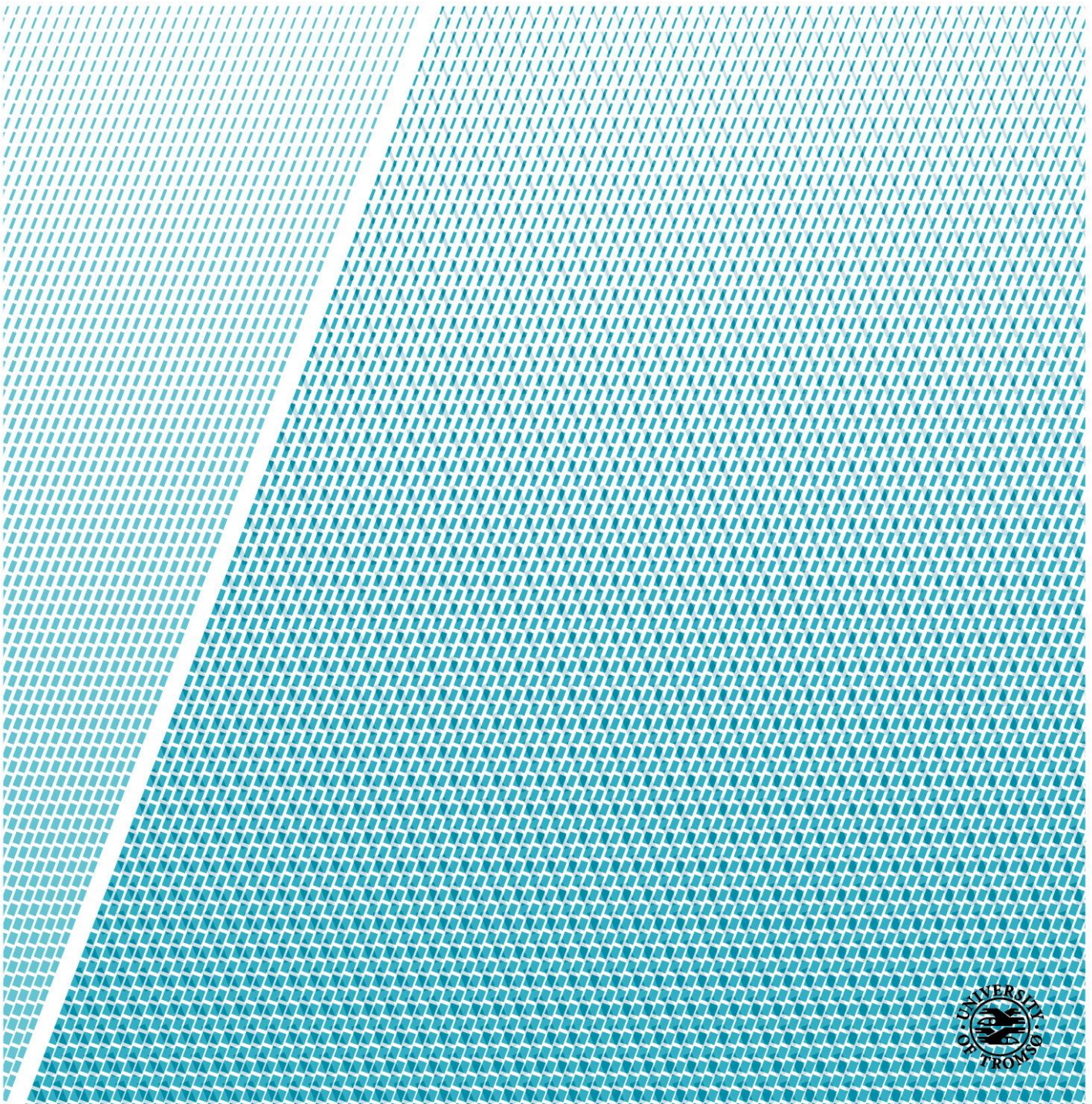

Abstract

Icing on power lines may lead to compromise safety and reliability of electric supply network. Prolong icing can lead to power breakdown and collapse of towers. Since power transmission lines are mostly overhead and could face direct impact of icing, and it is one of the main challenges faced by power distribution companies in cold regions.

When the ice accretion crosses the safety limit then deicing action can be carried out. We can find number of deicing methods that are used in different parts of the world. However, all of these deicing techniques have their own advantages and disadvantages on implementation.

It is one of the most difficult as well as dangerous process to perform deicing on power lines. If a fault is detected and that has been occurred due to icing or during routine maintenance, extra care must be taken in order to ensure safety of the personals when performing de-icing of lines. However, as technology evolved, new ways and techniques are adopted with the help of sensors that give quick feedback to control room in the national grid via wireless communication network for real time action.

In the thesis we have discussed atmospheric icing impacts on power lines in the cold regions across the world. A literature review has been done for anti-icing and deicing methods that are currently adopted in the power distribution network. Methods that are used against ice buildups have also been analyzed. This work also shows the impacts of icing and deicing techniques presently adopted, and also throws light on their pros and cons during maintenance operations. It provides an overview of the evolving technology trends that are practiced to ensure the availability of existing power transmission system in cold climate regions.

Keywords: Anti-icing /De-icing methods, electrical power network, ice calculation models, sensors, conductors, insulators.

Acknowledgment

This thesis is submitted in partial fulfillment of Master's Degree in Technology and Safety in High North in UiT The Arctic University of Norway. I would like to thank my supervisor, Dr Fuqing Yuan, for his guidance during the course of this work. I would also like to express my gratitude towards the UiT for providing me all the facilities that I required.

ALI RAZA SOLANGI

June 2018

Contents

CHAPTER 1.....	1
INTRODUCTION.....	1
1.1 BACKGROUND.....	1
1.2 RESEARCH PURPOSE.....	1
1.3 RESEARCH OBJECTIVES.....	2
1.4 STRUCTURE OF THE THESIS	2
CHAPTER 2.....	4
ATMOSPHERIC ICING IMPACTS ON POWER LINES	4
2.1 PROBLEM STATEMENT	4
2.2 MAJOR ICING DISASTERS IN COLD REGIONS.....	6
2.2.1. Event in North America.....	6
2.2.2. Event in Sweden.....	6
2.2.3 Event in UK.....	7
2.2.4 Event in Catalonia	7
2.2.5 Event in Norway.....	8
2.2.6 Event in Iceland.....	8
2.2.7 Event in China.....	9
2.2.8 Event in Japan	10
2.2.9 Event in Russia.....	10
2.3 TYPES OF ICING.....	11
2.3.1 Precipitation Icing	11
2.3.2 In-Cloud Icing	12
2.3.3 Sublimation Icing	12
CHAPTER 3.....	14
ICE FORMATION MODEL FOR THE LINE	14
3.1 SIMPLE ICE FORMATION MODEL	14
3.2 IMAI ICE MODEL	16
3.3 THE MAKKONEN MODEL.....	18
3.4 SIMPLE ICE THICKNESS DETECTION METHOD	20
3.5 LENGTH-STATE-FORMULA OF ICED CONDUCTOR	21
3.6 LENHARD MODEL.....	21
3.7 THE GOODWIN MODEL.....	22
3.8 CHAINÉ AND CASTONGUAY MODEL.....	23

3.9 MODEL FOR FREEZING RAIN ICE LOADS	24
CHAPTER 4.....	28
CONSTRUCTION OF TRANSMISSION NETWORK.....	28
4.1 OVERHEAD LINE COMPONENTS	28
4.1.1 Insulators	29
4.1.2 Conductors.....	30
4.1.3 Towers	31
4.2 EFFECT OF ICE AND SNOW ON THE TRANSMISSION LINE CONDUCTORS.....	31
4.2.1 Wake Induced Oscillation and Aeolian Vibrations	31
4.2.2 Ice Shedding	36
CHAPTER 5.....	38
ICING MONITORING SYSTEM	38
5.1 ICE BUILDUP MONITORING VIA METEO.....	38
5.2 ICE BUILDUP MONITORING EXPERIMENT IN ITALY	39
5.3 ICE BUILDUP MONITORING ON INSULATORS	41
5.4 ICE BUILDUP MONITORING VIA RADAR	44
5.5 SENORS FOR ICE CALCULATION	45
5.5.1 Capacitance Measurement Techniques	46
5.5.2 Ultrasonic Energy Measurement Techniques.....	47
5.5.3 Resonance Measurement Techniques.....	49
5.5.4 Microwave Energy Measurement Techniques	50
5.5.5 Impedance Measurement Techniques	50
5.5.6 Infrared Energy Measurement Techniques.....	51
5.5.7 Axial Load Measurement Techniques.....	52
5.5.8 Hybrid Measurement Technique	53
5.6 COMPARISON BETWEEN DIFFERENT ICE DETECTION METHODS	54
CHAPTER 6.....	60
ANTI ICING –DE ICING OF POWER LINES.....	60
6.1 INPECTION OF POWER LINE.....	61
6.1.1 Inspection Techniques Using Fixed Sensor.....	61
6.1.2 Inspection Techniques Using Fixed Cameras	63
6.1.3 Robots for Power Line Inspection	64
6.1.4 Human Controlled Aerial Vehicles	65
6.2 DE-ICING MEASURES	65

6.2.1 Passive Methods	66
6.2.2 Active Ice-Phobic Coatings	68
6.2.3 Mechanical De-Icing Method.....	69
6.2.3 Thermal Methods	70
6.3 METHODS BASED ON JOULE EFFECT	70
6.3.1 Joule-Effect Thermal and Electricity Analysis Model	71
6.3.2 Direct Current Joules Affect Method	76
6.3.3 Load Transfer Joule Effect Method.....	76
6.3.4 Reduced or Full Voltage Joules Effects Method.....	77
6.3.5 High Magnitude Short Circuit Method.....	77
6.3.6 Contractor Load Transfer Method.....	77
6.3.7 Methods Based on Dielectric Losses, Radiative Waves and External Heat Sources	78
6.3.8 Ultrasonic De-Icing for High Voltage Transmission Line	78
6.3.9 Reactive Current De-icing.....	79
6.3.10 Phase-Shifting Transformer De-icing.....	79
CHAPTER 7.....	80
DISCUSSION	80
7.1 ICING BRINGS FINANCIAL LOSES.....	80
7.2 EFFECTS OF ICE ON POWER INFRASTRUCTURE CROSSING DIFFERENT TERRAINS	80
7.3 COMPARISON BETWEEN DIFFERENT ICE FORMATION MODELS.....	80
7.4 EFFECT OF ICE AND SNOW ON POWER LINES.....	81
7.5 COMPARISON BETWEEN ICE MONITORING SYSTEM USING DIFFERENT SENSORS	81
7.6 DE-ICING AND ANTI-ICING OF POWER LINE.....	81
CHAPTER 8.....	83
CONCLUSION	83
REFERENCES:.....	85

List of Figures

Figure 1: Pole damage and pole fire in L-side and tower bend due to galloping in R-side	4
Figure 2: Icing on insulator	5
Figure 3: Snow load on power lines L-side and wind damage on R-side	5
Figure 4: Icing on 130kv insulator R-side and de-icing of 400kv line L-side	6
Figure 5: Wet and sticky ice on conductor L-side and damage tower on R-side	7
Figure 6: Burn mark in insulators due to ice rime L-side icing on towers R-side	8
Figure 7: Data showing damage to poles	9
Figure 8: Average temperature during winter period	9
Figure 9: Sea salt snow fall	10
Figure 10: Different kinds of ice structure during different temperature	13
Figure 11: Ice growth with time	16
Figure 12: Different Types of Ice	18
Figure 13: Air streamlines and droplet trajectories around a cylinder	20
Figure 14: Uniform radial ice accretion rate for the simple model as a function of precipitation rate and wind speed	25
Figure 15: Power transmission/ distribution of Finish electricity network	28
Figure 16: Over Head Power Line Components	29
Figure 17: Suspension insulators based on different materials (a) composite long rod insulator (b) glass cap-and-pin insulator (c) porcelain long rod insulator	29
Figure 18: Aluminum Conductor Composite Reinforced (ACCR) Type Conductor, (A) ACCR Cross Section, (B) ACCR, (C) ACCR-TW	30
Figure 19: Stockbridge dampers with missing masses on a transmission line L- side and Stockbridge dampers damaged during galloping tests R-side	32
Figure 20: Galloping types in overhead lines	34
Figure 21: Interphone spacers on transmission line	35
Figure 22: Meteo with Support arm and sensors	38
Figure 23: Scheme of Processing Data Measured	39
Figure 24: Scheme of all measurements collected at the experimental station	40
Figure 25: ACSR Conductors Subjected to Slow Rotation (L-Side) and Measure the thickness of Snow Sleeve. ACSR Conductors Intended for the Simulation of AI Current (R-Side)	41
Figure 26: Image Recognition Algorithm Flow Chart	42
Figure 27: Grayscales Comparison Pictures	43
Figure 28: Ice Recognition Experiment	44
Figure 29: Relation of attenuation with frequency in High Frequency tract, Lines with length of 16 630 m (red line) and 45 700 m (blue line)	45
Figure 30: Construction of Weinstein Ice Sensor	47
Figure 31: Design of Watkins sensor	49
Figure 32: T44 Holo Optic ice sensor	52
Figure 33: Ice Monitor by Combitech	53
Figure 34: A configuration of miniaturized RICE device	54
Figure 35: Cam image with ice and without ice accumulation	56

Figure 36: Transmission line circuit configurations	61
Figure 37: Data transfer from transmission tower to control room Electrical power research institute USA	62
Figure 38: Central icing monitoring systems	63
Figure 39: Camera monitoring of transmission line	64
Figure 40: Robot by Expliner	64
Figure 41: Surveillance helicopter-T&D world magazine	65
Figure 42: illustration of counterweight on transmission cable	68
Figure 43: Snow melting conductor	68
Figure 44: Mechanical method for de-icing	69
Figure 45: Ice shedder after Volat.C, Farzaneh.M 2005	70
Figure 46: DC methods for deicing of 735KV line by	76
Figure 47: Steam cleaning of insulators	78
Figure 48: Ultrasonic de-icing device with one clamp	79

List of Tables

Table 1: Different icing density and their effects	17
Table 2: Conceptual evaluation of the models for conductor icing in freezing precipitation	27
Table 3: Different Ice Detection Methods	55
Table 4: Comparison between several atmospheric Icing Sensor Techniques and Patents... ..	58
Table 5: Surface free energies for different compounds	67
Table 6: De-icing current values that is required for different types of conductors	73
Table 7: Different joules effects by Pascal Prud Homme et al 2005	75

CHAPTER 1

INTRODUCTION

1.1 BACKGROUND

In parts of the world where icing phenomenon occurs, extreme low temperatures and heavy icing brings adverse effects on infrastructure by affecting their performance in terms of material degradation, malfunctions, breakages, stiffness, cracking and low performance etc. Similarly, electrical power network faces several problems under icy conditions. Since transmission lines are spread across long distances from generating stations to distribution grids. Such network runs through plane fields, high mountains, and small river crossings and covers long distances. During icing events, weight of ice puts an additional load and stress on the network and increases the possibility of power breakdown due to ice accretion. Previous events show that ice storms bring heavy losses to the power networks and restoration work took several days to weeks to resume the power supply. During ice storm ice accretion occurs on conductors, insulators and towers, which can lead to tripping of line, structure collapsing and additional load on conductors. Once the fault generates, it takes long time to normalize the network, since repair activities require fault pinpointing followed by mobilization of manpower, logistics, material, and check on adverse weather conditions etc. In this work we have reviewed previous power losses in cold regions during ice storms and the financial losses that occur with a power breakdown. The preventive measures that have been taken to make the power transmission more reliable and robust have also been discussed. During recent times advancements have been made in terms of ice load detection, structure improvements, anti-icing and de-icing techniques, that enables continuous power supply even in harsh conditions. Several new methods have been tested for ice detection that gives good results under different cold conditions. Air temperature and wind directions play an important role in ice formation.

1.2 RESEARCH PURPOSE

The purpose of the thesis is to define how icing affects the electrical lines and its components. What type of stresses an electrical network can face. Which areas are more prone to the ice storms and what are the challenges and best practices to overcome icing events.

1.3 RESEARCH OBJECTIVES

The research objectives are:

- i. To show how an icing event damage an electrical network and cause the increase in operation and maintenance cost.
- ii. To define various types of icing, and show which type of ice is the most harmful to damage power line.
- iii. To explain the basic components of transmission lines affected by icing events.
- iv. To show different ice calculation models.
- v. To compare different ice inspection methods and different sensors for ice calculation.
- vi. To explain various anti-icing/ de-icing methods used in maintenance of power lines.

1.4 STRUCTURE OF THE THESIS

The thesis consists of following chapters,

Chapter 1 introduces the background of the problem and discusses research purpose, objectives and research questions.

Chapter 2 describes different types of icing, impacts of icing on power lines and major icing disasters in cold regions.

Chapter 3 elaborates on different types of ice formation models and comparison between them.

Chapter 4 is about construction of transmission lines and the effects of snow on power lines.

Chapter 5 discusses ice buildup monitoring on line and insulators and different types of sensors for ice calculations and their comparison.

Chapter 6 elaborates anti-icing and de-icing of power lines.

Chapter 7 is all about discussion on power line icing and Anti-icing and Deicing methods.

Chapter 8 gives conclusion of the entire work.

CHAPTER 2

ATMOSPHERIC ICING IMPACTS ON POWER LINES

2.1 PROBLEM STATEMENT

In most parts of the world where icing phenomenon occurs on power transmission lines, icing can bring numbers of problems for instance galloping, short-circuiting and collapsing of towers due to extra weight added by ice.

Transmission towers are designed to withstand galloping, but if the Power line touches or get close enough to the grounded part like steel tower, then it can lead to short circuit fault. That can energize protective relays and breaks the circuit under fault signal. Galloping occurs when freezing rain sticks on transmission tower and conductors that may result ice accretion. Strong wind blowing across those icicles and conductors can also cause power lines in jumping motion and the stronger the wind gets, greater will be the galloping. It is noted that with six millimeters of ice under constant wind of 30km/h blowing perpendicular to transmission line is the ideal condition to create galloping. In distribution network of 11kv, icing also affects power supply. Since lower voltage transmission network mostly uses wooden poles with insulators holding the conductors and over the time, crakes generated in conductors resulted in pole fire. Some other factors that includes dirt and dust covering the insulators, moisture in the air, dense fog, rain, and wet snow may cause short circuit. Figure 1 shows pole damages due to galloping and pole fire [1][2].



Figure 1: Pole damage and pole fire in L-side and tower bend due to galloping in R-side [2]

The other hazard caused by icing to the transmission lines is accumulation of snow on towers and insulators. Insulators are determined by their loading capacities and should withstand defined electric stresses and lower probability of flashover failures.

They should also bear short duration surges that may occur by switching or lighting. Figure 2 shows an insulator covered in ice [3].

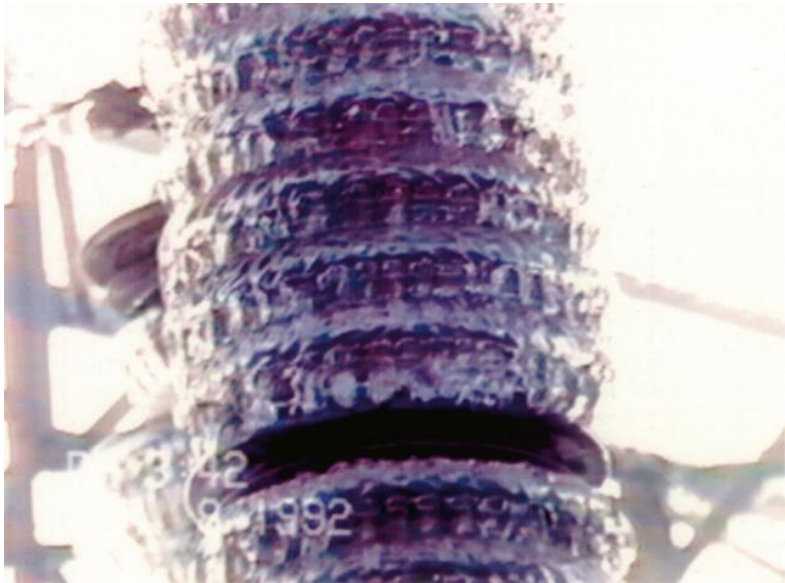

Figure 2: Icing on insulator [3]

Practically icing on power lines can affect the network in two ways. First, ice accumulations on insulators reduce their electrical strength and thus result in icing flashover. Secondly, it reduces the air gap. For example, heavy ice conductors and ground wires reduces the air gap between them, which followed by sleet jumping when ice starts to melt on the conductor and may results in flashovers. Icing can break the conductor and topple towers as well. In south of Norway two 420kv transmission lines suffered heavy damages due to excess ice loads, that were 4 to 5 times of the bearing limit. In forests, heavy load of snow under wind can bring wind-throw or stem breakage, which is one of the most harmful occurrences especially in European forests. Figure 3 shows the effects of wind throw [4][5].



Figure 3: Snow load on power lines L-side and wind damage on R-side [4]

2.2. MAJOR ICING DISASTERS IN COLD REGIONS

Icing disasters have occurred in many parts of the world such as North America, Europe, Nordic region, Asia and South Africa. We have highlighted some of the major events that were caused by icing.

2.2.1. Event in North America

The icing event in North America considered one of the major disasters caused by icing, in which we saw power outage in eastern Canada and America. That resulted in effecting the residents of Quebec Canada from 4th to 10th January 1998 as freezing rain fell for nearly four days, and 110mm of ice was recorded in Montreal region and St-Lawrence alone. It was estimated that 1.4 million people were left without power and there was huge damage to electrical infrastructure and 1000 towers and 3000 km of power lines destroyed. The amount estimated for restoration was 6.4 billion \$.

2.2.2. Event in Sweden

In Sweden in 1999, power was interrupted for 6 hours in southwest part of country in 130-400kv network. It was later discovered that ice built-up on an insulator close to coastal area resulted in flashovers. In another event, a 130kv insulator caused power interruption. However, that was not the result of flashover but very favorable weather conditions for ice buildup. As the winds coming from the sea holding salt particles with them. It was decided that 400kv substation required automatic washing of substation insulators but temperature plummeted and followed by heavy snow that covered the insulator completely with ice. This eventually led to a flashover and inspection team found out that the conductivity of melted icicles reached 680 $\mu\text{S}/\text{cm}$ due to salt particles and that has affected 400kv lines. In Sweden two types of insulators were used. The glass type and the cap and pin insulators, due to their long life and better performance in contaminated environments. Figure 4 shows the type of insulators used and their cleaning during breakdown [6].



Figure 4: Icing on 130kv insulator R-side and de-icing of 400kv line L-side [6]

2.2.3 Event in UK

In 1990 heavy wet snow interrupted various low voltages to 400kv lines. Some cities also suffer power cuts for 30 hours and as the storm moved from north to south, over one million customers suffered outages. Moreover, some of the customer's power deprived for 9 days. Icing also affected Scotland and North Wales. As temperature stayed around above 0°C, and rainfall equal to 30 mm and wet snow precipitation in 14 hours with winds blowing around 15-25 m/s. Power lines from East to West experienced the heaviest snow with radial ice thicknesses of up to 200 mm on single conductors which could rotate Twin Lynx conductors and accreted ice horizontally lead to many galloping incidents and line failures.

2.2.4 Event in Catalonia

In 2010 heavy snow was recorded in the coastal area called Costa Brava. The important thing in this event is the fact that the snow was relatively sticky because of being wet snow precipitation between -1 °C and 2 °C, and snow fall was also heavy. The falling rate of snow was 1mm/min consisting of large snowflakes, since the area was below 500m and such weather was unexpected and the transmission towers were not designed for such weather. This resulted in extra load on power lines and towers, and icing destroyed the network and an estimated 200 thousand customers suffered power interruptions. It took six weeks for the power companies to restore the supply to normal. The company suffered heavy financial losses as well as they had to redesign overhead lines with focus of ice loads. They have also considered a minimum of ice load thickness in design as follows,

Weight of ice = $0.18\sqrt{d}$ daN per linear meter (daN = deca Newton) where “d” is the diameter of the conductor in millimeters. Figure 5 shows damages caused by snow.

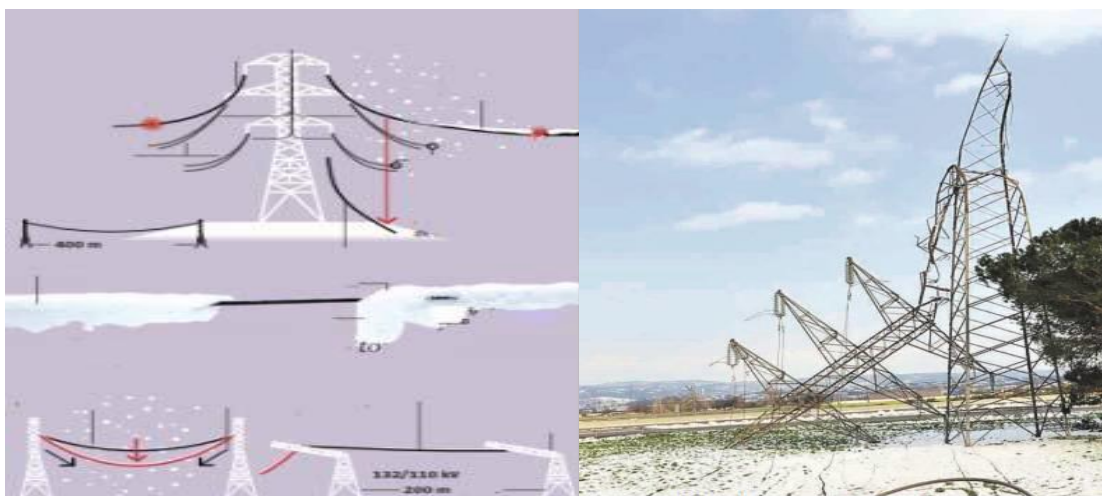

Figure 5: Wet and sticky ice on conductor L-side and damage tower on R-side [6]

2.2.5 Event in Norway

Norway experienced one of the heaviest ice loads on transmission lines during the early 60s. The measured ice accretion was up to 1.4m x 0.95m that weighted 305 kg/m. The line that had icing was used for radio and TV transmitter and was 1412 m above sea. It was almost impossible to de-ice the line in a short span. It was observed that the line was constructed on the top of mountain ridge and the line was closed to coastal area and it was exposed to maximum humid south- west winds from the sea. It was also observed that topography also has an important influence on icing and we can experience different ice behavior. For example, freezing rain occurs mostly in the basins and depressions in which cold air may be trapped and hot air with precipitation may intrude the air aloft. Also mountain range up to 100 to 50 m tall and having winds upward direction are good to minimize the icing, but wet snow may happen at all altitudes and leeward side of mountain and ridges. Figure 6 shows damaged towers and insulators due to icing [6].

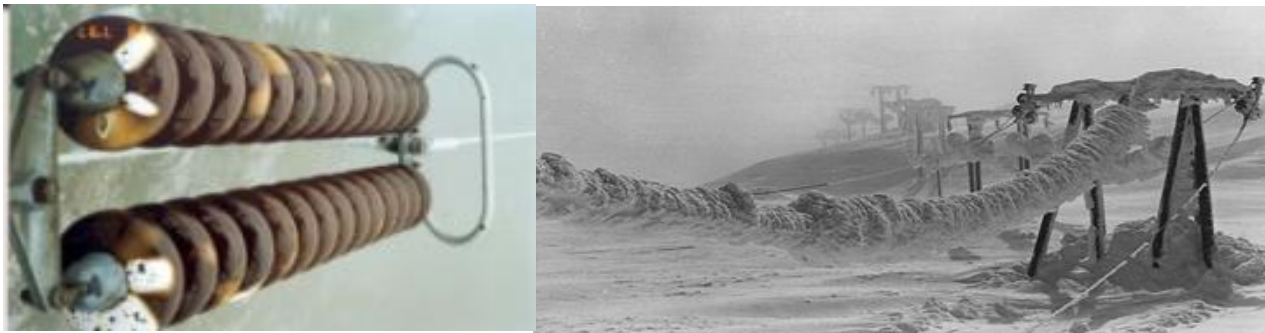

Figure 6: Burn mark in insulators due to ice rime L-side icing on towers R-side [6]

2.2.6 Event in Iceland

In Iceland during winter temperature roves around 0 °C in the coastal areas, and wet snow is common fixture during winter. With in-cloud icing in the areas that are above the sea levels that is over 300m. After series of breakdown problems due to icing in the 90s, redesigning work began in distribution network from 11kv to 33kv by collecting most vulnerable points in the network and converting them into underground cables where it was possible. Figure 7 illustrates data of broken poles [6].

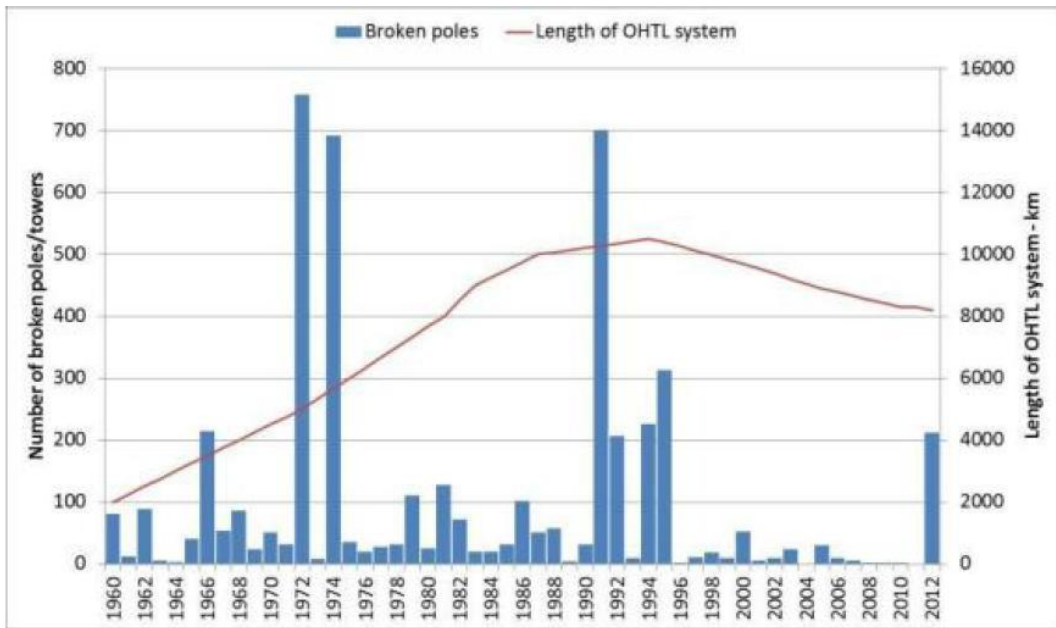

Figure 7: Data showing damage to poles [6]

2.2.7 Event in China

In the year of 2008, the central and southern parts of china faced serious icing problems, and it was recorded that average temperature was under 0°C in seventeen out of thirty one provinces. Power breakdowns were recorded in 36740 lines with 2018 transformers shut down and 8381 electrical towers collapsed between voltages of 110kv to 500kv. During that period large numbers of icing flashovers, damaged substations and collapsed towers recorded. Hunan province was badly hit by cold weather which experienced a power outage for more than 2 weeks. The economic loss was estimated around 3.5 billion dollars. Figure 8 below shows the map where temperature was very low [6].

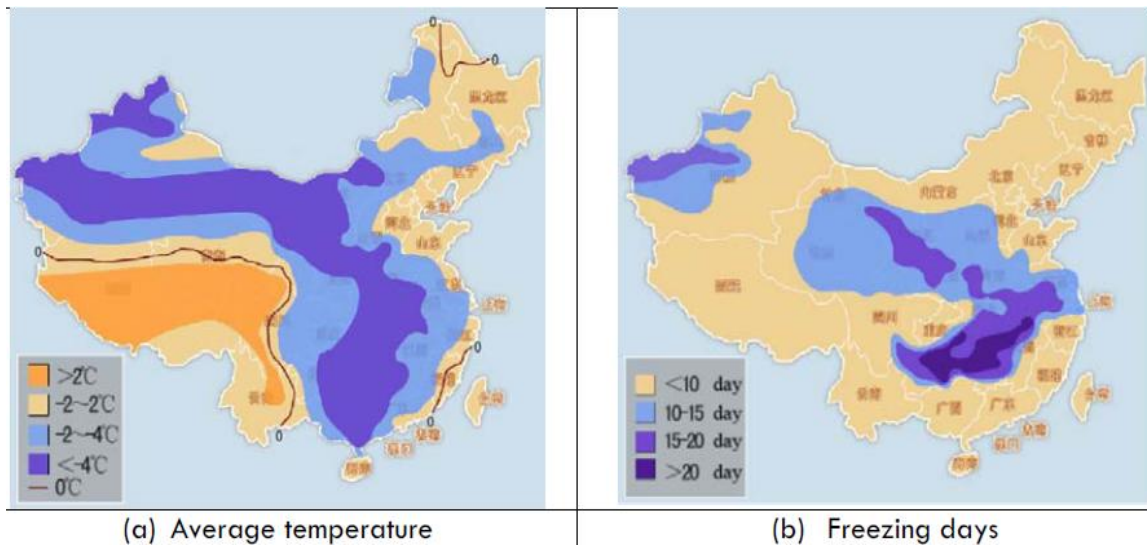

Figure 8: Average temperature during winter period [6]

2.2.8 Event in Japan

In December 2005 in Japan, power breakdown affected around 650,000 households in northern part of Niigata and it took 31 hours to clear the faults. It was also observed that short circuit occurred in several locations due to snowing on the insulators and wet snow coupled with sea salt caused short circuits and galloping of several lines. It was also discovered that on 22nd December around 15:00 local time, snow started with high winds on average 10 m/s as the depression passed and temperature was about 0° to 2° C which is suitable for wet snow build-up. Icing lasted for up to 15 hours that accrete on power lines. In Figure 9 we can see how icing having salt particles was formed [6].

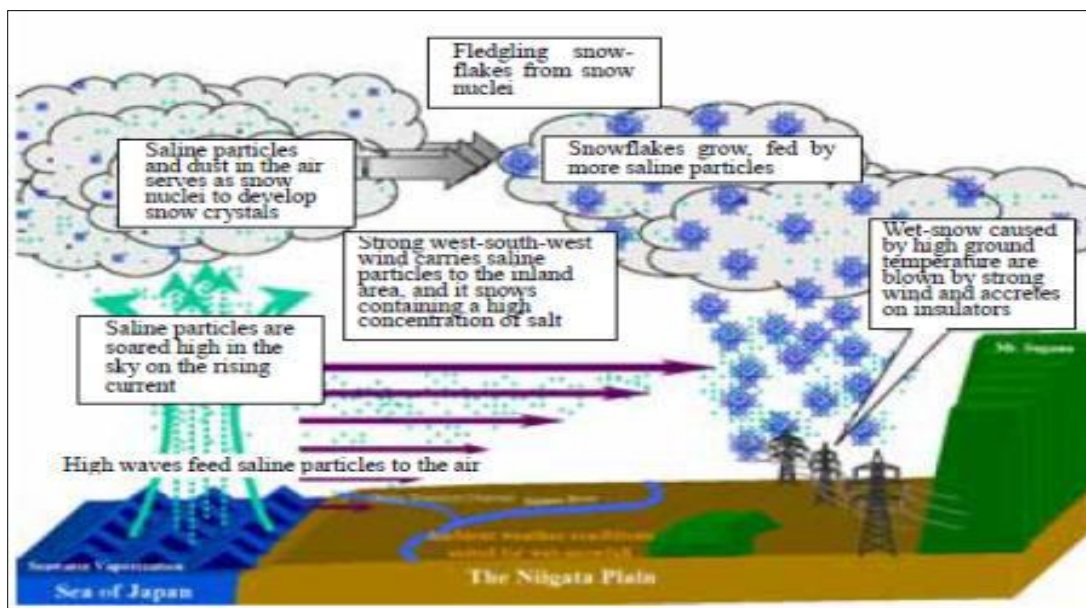

Figure 9: Clouds carrying saline particles causes salt snow fall [6]

2.2.9 Event in Russia

Failure is characterized into accident and incident. Accident is an event in which there is equipment damage, burnout and power outage for a long time. Incident is an event where there is no or small equipment damage or power outage for a short time. In Russia, every failure and incident is followed by an investigation that involves three main sections:

1. **Address section** – with main info on failure: day/time of failure beginning, location, damage, etc.
2. **Description section** – with network operating conditions before failure, failure beginning and development, failure causes, damages description.

3. **Damaged equipment** description section – with information on damaged equipment type, brand and technical parameters.

During 1997 to 2007, 110-750 kV substations suffered nearly 6,500 events of substations equipment failures. In which major chunk of failures happened with switches (46,2%) and disconnections (30,4%). Transformers had relatively minor failures (12,9%). Icing accumulation had very less impact and did not have a large effect on damage Statistics to main substation's equipment. So out of all the examined cases, no more than 2-3% of damages occurred due to icing events.

2.3 TYPES OF ICING

Icing on the transmission lines can be observed when temperatures are between -3°C to $+2^{\circ}\text{C}$. Freezing temperatures usually make conductors cold and if the temperature above the ground increases, then ice precipitation reduces through warm air and rain, and freezes only on contact with the cold conductor. When air above the conductor becomes too cold then precipitation freezes in the air and does not stick to the conductor. Most suitable temperature for icing is -3°C and $+2^{\circ}\text{C}$ having wind velocities around 8 to 9 miles per hour.

Atmospheric icing is a general term used of freezing of water substance and they have three basic types (i) precipitation icing, (ii) in-cloud icing and (iii) sublimation icing. The first two types can bring severe damages on transmission line.

There are several factors that influence icing for example, wind speed, temperature, micro-climate, micro-terrain, also content of super cooled water in the air.

2.3.1 Precipitation Icing

Precipitation icing can result in the glaze of wet or dry snow. Another factor is the change in temperature that affects the ice variation that is close to ground. It can be observed in any place, where precipitation can combine with freezing temperature. Wet snow accretion occurs with snowing and is considered most extreme. Particularly in countries where high precipitation near freezing points occurs like most European countries. Snow cover forms by freezing rain (super cooled water) falling on conductor surface, whose temperature is near to 0°C . This super cooled degree of water drops has got something to do with the size of the water drop. The Lower the degree of temperature is, the bigger the drops will be. Wet snow is mostly formed under a very close surface to air temperature interval just above 0°C . Snowflakes falling from the sky through the air with temperature reaching close to the ground will eventually collide with temperatures above freezing point. Since the temperature for wet

snow formation is between +0.5 to +2 °C, when snowflakes meet above freezing temperatures they melt and when liquid water appears in the snowflakes, they become sticky to other objects. Dry snow is formed when wind speed is low around 2m/s. This sometimes results in heavy snowfall but its density never crosses $100\text{kg}/\text{m}^3$ which means its mass load is lower than the load carrying capacity of power lines. Once it hits the conductor surface it would freeze there. Since the level of releasing latent heat is low during freezing temperatures and we see a film of water on conductor surface, and a glaze is produced. It's considered most harmful to overhead lines due to its high density and strong adhesive power.

2.3.2 In-Cloud Icing

In cloud icing occurs in clouds having super cooled droplets. It mostly occurs at high altitudes like mountains and impact installations installed there. Its intensity and duration depends on the amount of liquid water in clouds, temperature, speed, depth of cloud and distance from the coastline. Hoar frost is a phenomenon in which vapor of water converts into solid. It happens during cold winter nights and affects power lines in form of corona discharge that is an energy loss in form of noise and sparks. The in-cloud icing is basically ice frozen by the super cooled cloud/fog in the atmosphere when it comes in contact with transmission lines. Such types of icing happen without rain or snow, and are mainly dependent on air speed and humidity. It is small in size and water droplets can release the latent heat swiftly when freezing but it cannot make water layer on conductor's surface, and only makes rime.

2.3.3 Sublimation Icing

Sublimation icing is easy to shed due to its weak adhesion. This icing is formed when water vapor in the atmosphere freezes, and also called crystalline rime. It does not pose any big danger to overhead conductor. There are numbers of factors that influence the model of ice such as: water level in the air, wind direction and speed and the temperature. As we know temperature of icing is always below 0°C, if it's combined with super cooled degree of water droplets then icing occurs. When the conductor experience constant wind blowing towards its surface that can result in adverse effect on heat transfer. If the wind direction is in line with the conductor then there can be less icing and if it's perpendicular to wires then it's most effective. There can be different kinds of ice crystals that can occur in different temperature. Experts find needle shaped crystal most problematic. They can be formed in around -5 degrees temperature. They have hallowed cylinder shape with length up to 1.1mm. Figure 10 blow shows different kinds of ice structure during different temperature [9].

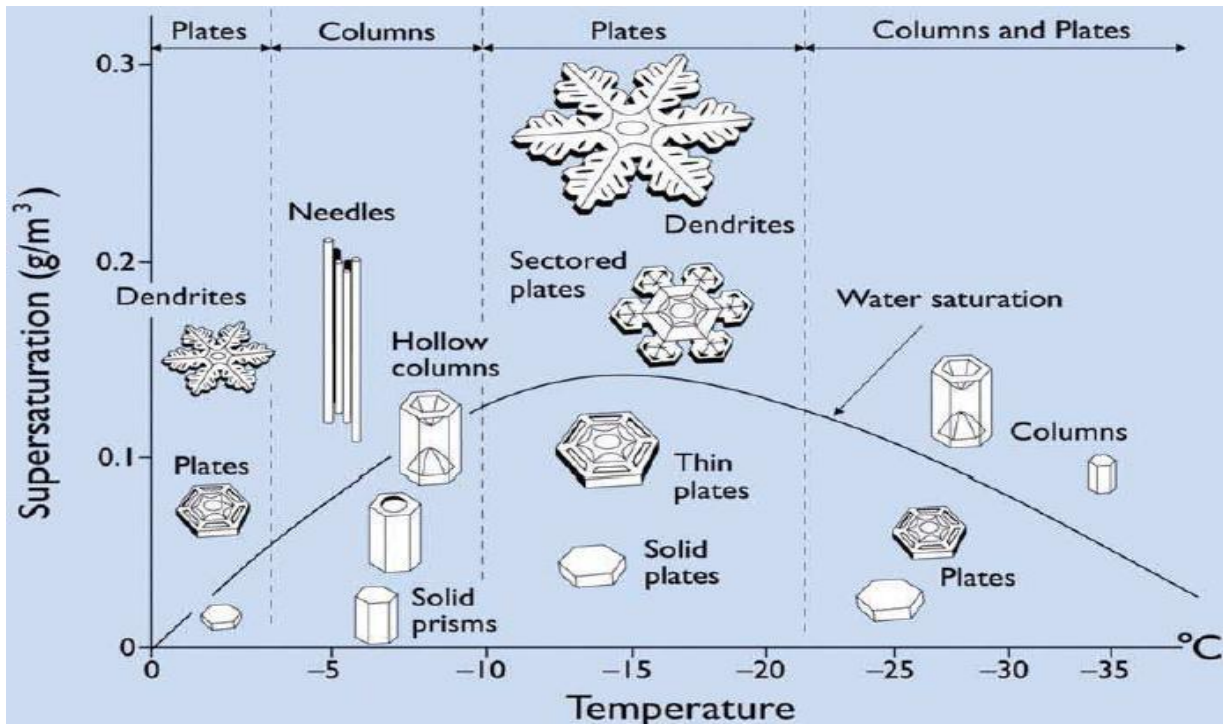

Figure 10: Different kinds of ice structure during different temperature [9]

If the transmission line is close to the sea, then we may observe also sea spray icing. These spray droplets carried out by wind and the temperature is around $-2\text{ }^{\circ}\text{C}$. Such droplets include salinity of sea in drops and considered as important factor that can effect power supply [1][7][8][9].

CHAPTER 3

ICE FORMATION MODEL FOR THE LINE

In order to simulate icing of power lines following parameters should be included to have correct results for example: radius of conductor, wind speed, precipitation intensity, the angle between the cable orientation and the falling speed of the drops and we can calculate vector velocity and flux density of impinging water. During freezing rain, the drops become so big that the collision efficiency may be taken as unity. Also, the water that hits the conductor may not freeze on the surface and can be partly lost by shedding.

There are several models that are used for freezing precipitation such as: Imai, Lenhard, Chainé and Castonguay, Anon, Goodwin, Lozowski, Makkonen, Finstad and so on. However, all such models are not fully capable to give correct results but are quite useful. Below we discuss few of these ice models to have a basic understanding of ice formation on conductor [25].

3.1 SIMPLE ICE FORMATION MODEL

We can find several models on icing phenomenon and ice accretion that can be divided in two models. The first model uses physical parameters and determines heat balance in the objects and that requires numbers of parameters and the other model make use of meteorological data to calculate the ice buildup. The model that uses heat balance between objects is a bit challenging to achieve, since the surrounding temperature is constantly changing and can give different reading during different hours. The model below makes use of metrological data for three-dimensional object. When significant liquid precipitation occurs at freezing temperatures, glaze ice will form. Glaze ice is considered strong in texture and not easy to shed and have very strong adhesive power and density between 0.6 to 0.9g/cm³. Other types are granular rime, crystalline rime, mixed rime and wet snow.

A simple ice formation model is one that calculates the ice precipitation that hits the line from every direction. The mass-flux is the amount of rain that occurs in a location in one-unit time and the vertical mass-flux can be given as:

$$mv = P\delta \quad (3.1)$$

Where: P = Precipitation rate in $\frac{mm}{h}$ that can be taken as ice load per hour

δ = water density in g/cm³

Let v_{mean} can be mean wind speed in meter per second, hitting the perpendicular component that can be estimated in 0.7times to the gust wind then:

$$v_{mean} = 0.7 \omega \beta(t) V_{max} \quad (3.2)$$

v_{mean} used to calculate the amount of ice that is deposited on the line. The relation between v_{mean} and the gust or maximal wind v_{max} can be computed by: $v_{mean} = Kg v_{max}$

The factor “kg” changes for different ice storms under different terrains. Here “kg = 0.7” is used in the investigation of the Swedish ice storm in the year of 1921.

$$\text{The horizontal mass flux is given as: } m_h = 3.6 V_{mean} v \quad (3.3)$$

$$v = \text{liquid water content g/cm}^3, \quad \text{so } v = 0.072 P^{0.88}$$

Total mass flux hitting the line that is:

$$m_o = \sqrt{m_v^2 + m_h^2} \quad (3.4)$$

by putting the values:

$$m_o = \sqrt{P^2 \delta^2 + 3.6^2 V_{mean}^2 v^2} \quad (3.5)$$

The increase ice thickness on the line:

$$\Delta R = \frac{m_o}{\pi \delta i}, \Delta R \left(\frac{mm}{h} \right) \quad (3.6)$$

δi is the density of ice in g/cm^3

$$\Delta R = \frac{1}{\delta \pi} \sqrt{(P \delta)^2 + (3.6 V_{mean} v)^2} \quad (3.7)$$

P is the precipitation rate in the ice load model equation in which x and y are the coordinates and t represent time:

$$\text{Ice Model Equation: } L_1(x, y, t) = L_1(x, y, z - \Delta t) + \Delta R(x, y) \Delta t, \quad (3.8)$$

This ice model equation above does not have the line radius, and the ice thickness model does not take consideration of initial radius of line, and weight of ice becomes larger if the line is thick [10].

3.2 IMAI ICE MODEL

The other model that take consideration of power line radius is called Imai model, that determine ice loads by heat transfer on wire surface and the intensity of ice proportional to the negative air temperature (-T) is irrelevant to precipitation.

$$\frac{dM}{d\tau} = C_1 \sqrt{VR} (-T) \quad (3.9)$$

Where

V : wind speed, m/s; t : time, hours (h); C1 : constant integrating Eq (3.9);
 T : air temperature, °C; M : ice mass, kg.

$$M = C(V(-T)\tau^{4/3}) \quad (3.10)$$

Ice mass calculation formula based on experimental data (T=-2°C, V= 2m/s) is:

$$y = 0.00621\tau^{4/3} \quad (3.11)$$

Comparing equation: 3.9 and 3.10 we have:

$$M = 1.7927 \times 10^{-3} \sqrt{V(-T)} \tau^{4/3} \quad (3.12)$$

Ice load on contact wires with random length can be calculated by:

$$M = 8.9635 \times 10^{-3} \times L \times \sqrt{-VT} \tau^{4/3} \quad (3.13)$$

Where L is length of random wires. Figure 11 shows ice grown with time [8].

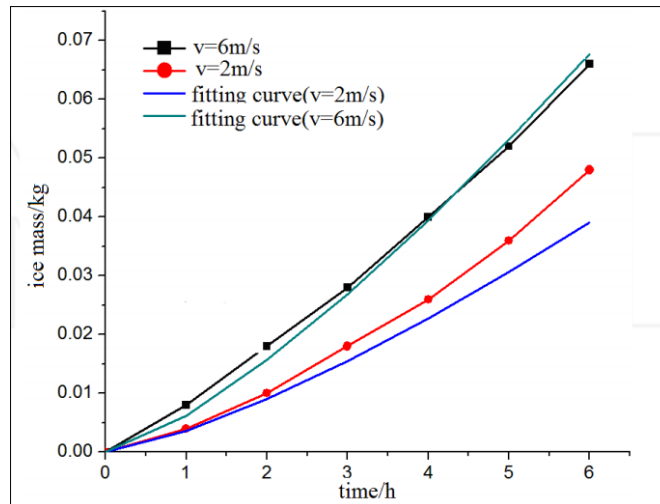

Figure 11: Ice growth with time [8]

Table 1 describes different snow densities.

Ice and snow types	Density (kg/m^3)	Description
Glaze ice	700-900	Trans lucid solid ice, sometime with icicles underneath the ground wire and conductors. The density may vary with the content of air bubbles. Adhesion is very strong and difficult to knock off.
Hard rime	300-700	Homogenous opaque structure with inclusions of air bubbles. Pennant shaped against the wind on stiff objects, More or less circular on flexible wires and conductors. Adhesion is very strong and difficult to knock off even with a hammer.
Soft rime	150-300	Granular structure, feather-like pennant shaped. Can be removed by hand.
Wet snow	100-850	Mainly depends on wind speed and torsional stiffness of conductor. When temperature is zero it may have high liquid content, slide to bottom side of the object and slip off easily. If the temperature drops below zero after accretion then adhesive strength may be very high. Various shapes and structures are possible.
Dry snow	50-100	Very light pack of regular snow. Various shapes and structures are possible. Very easy to remove by shaking of ground wires/conductors,
Hoar frost	< 100	Crystal structure (needle-like) low adhesion, easily blown off.

Table 1: Different icing density and their effects [11]

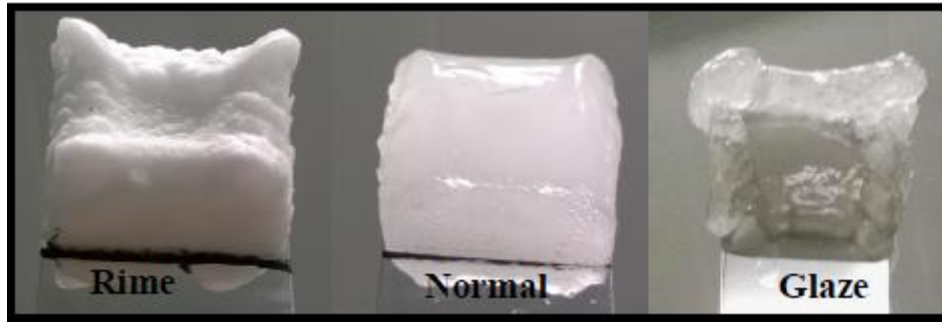

Figure 12: Different Types of Ice [15]

In Figure 12, we can see different types of ice having different shapes, densities, properties and characteristics. According to standard ISO-12494 density of soft rime varies between 300-600 kg/m³, hard rime 600-900 kg/m³ and glaze ice around 900 kg/m³. We can see white rime have irregular shape that is direct result of wind direction and glaze ice is transparent in appearance and evenly shaped that has runback ice and icicles and the normal ice do not have icicles or runback ice. It is translucent unlike transparent glaze ice [15].

3.3 THE MAKKONEN MODEL

There is no specific ice model that can cover all the criteria to simulate wet snow accretion. One can find several different models, but all of them are based on one basic equation for ice accretion, described in ISO standard 19494 for icing of structures also called Makkonen Model. In this method ice is buildup over standard cylinder. Ice loads formed due to particles in the atmosphere that collides with power supply structures. For example, liquid or solid particles and mixture of ice and water that can be expressed in mass flux density. The mass flux density of the impinging particles F can be shown as product of Arial mass concentration of the particles. w is the effective velocity, v of the particles with respect to object then $F = wv$, then rate of icing can be shown as rate of change in ice mass (M), A can be taken as surface area, v is the wind, and LWC are the three coefficients. These coefficients describe as sticking, collision and accretion efficiencies. Also, the Icing-model needs to know the cloud particle numbers concentration.

The basic ice accumulation equation can be shown below:

$$\frac{dM}{dt} = \alpha_1 \alpha_2 \alpha_3 \omega v A \quad (3.14)$$

Where,

α_1 is collision efficiency,

α_2 is coalescence efficiency,

α_3 is accretion efficiency,

A is cross sectional area of object

α_1 can be taken as collision speed of the particles, that is impinging mass flux density to the aerial mass density. These small particles that deflect around the structure and their collision efficiency can be taken as less than unity. α_2 are those particles that hit the object and stick to the object. Coalescence efficiency is less than unity when the particles bounce from the surface, when they stick on the object their residence time on the object is sufficient enough to affect the icing rate due to heat transfer with the structure. α_3 is the accretion efficiency, i.e. The ratio of the ice mass flux density to the mass flux density of the particles that stick to the surface. The accretion efficiency is less than 1 when the heat accretion is unable to freeze all the liquid particles that stick to accretion due to accretion being too small.

The parameters taken into account for precipitation icing (wet snow and freezing rain) are:

- i. Air temperature
- ii. Precipitation rate
- iii. Wind speed
- iv. Direction of wind
- v. Visibility
- vi. Relative humidity
- vii. Liquid water content of snow flakes
- viii. Surface air temperature

The parameters taken into account for in-cloud icing

- i. Wind speed
- ii. Direction of wind
- iii. Droplet size distribution
- iv. Air temperature
- v. Liquid water content in the cloud

Also with that we need to consider parameters for structure like surface properties, shape, tensile strength, stiffness etc. Makkonen model is used for calculating icing effects on structures. In Figure 13, we can see Air streamlines and droplet trajectories around a cylinder [3][12][13].

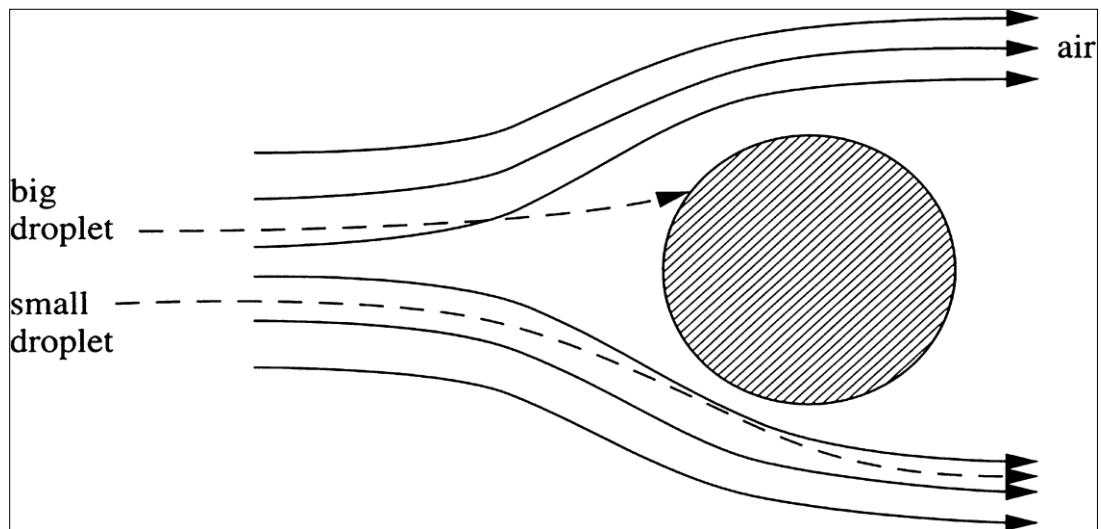

Figure 13: Air streamlines and droplet trajectories around a cylinder [3].

3.4 SIMPLE ICE THICKNESS DETECTION METHOD

In power transmission network, the conductor load ratio is taken as conductor's load per length (km) and per cross sectional area (mm^2) that consists of conductor weight ratio.

γ_1 =conductor weight ratio, γ_2 =ice weight ratio, γ_3 = wind pressure ratio.

$$\gamma_1 = \frac{9.80665m}{1000s}, \quad \gamma_2 = \frac{27.728b(b+d)}{1000s}, \quad \gamma_3 = \frac{0.6125ac(2b+d)v^2}{1000s} \quad (3.15)$$

In equation (3.15) m can be taken as conductor mass per length (kg/m) and s is the cross-sectional area, mm^2 b is the average ice thickness of the ice conductor (mm). d is conductor diameter (mm) and a is the asymmetry- coefficient of wind velocity. Similarly, c is the shape coefficient of wind load whereas v is the wind velocity in m/s.

$$\text{Equation (3.15) can be written as: } \gamma_z = \sqrt{(\gamma_1 + \gamma_2)^2 + \gamma_3^2} \quad (3.16)$$

The formula of relationship between average conductor ice thickness and comprehensive load ratio is written as follow:

$$\begin{aligned} & 10^6 s^2 \gamma_z^2 - 96.17038 m^2 \quad (3.17) \\ & = 768.8226 b^2 + (b + d)^2 + 0.375156 \times a^2 c^2 v^4 \times (2b + d)^2 + 543.8307 \times mb(b + d) \end{aligned} \quad (3.18)$$

3.5 LENGTH-STATE-FORMULA OF ICED CONDUCTOR

The conductor length equation can be derived from catenary equation that calculates the length correctly; when two conductors's hanging points are linked to transmission towers that have same height. The line length equation in that case can be written as:

$$L_z = \frac{2\delta z}{\gamma z} sh\left(\frac{\gamma z l}{2\delta z}\right) \quad (3.19)$$

In equation (3.19), l is the distance between two adjacent towers, and δz can be taken as horizontal stress of the lowest position of conductor.

If we take L_1 is the length between two adjacent towers and the air temperature is T_1 and wind speed is V_1 and the average ice thickness of line is b_1 . Similarly, L_2 is the length when air temperature is T_2 and wind speed is V_2 and the average thickness of b_2 , then the relationship between L_1 and L_2 .

$$L_2 = L_1 [1 + \alpha (\tau_2 - \tau_1) + (\sigma_2 - \sigma_1)/E] \quad (3.20)$$

E in the equation represent elastic –coefficient and α is expanding temperature of co-efficient of the conductor that is: $\sigma_i (i=1,2)$ is the corresponding horizontal stress of the conductor's lowest point [14].

3.6 LENHARD MODEL

This model lies on the basis of empirical data by taking into account weight of ice per meter M .

$$M = C_3 + C_4 H_g \quad (3.21)$$

Where H_g the total amount of precipitation is during ice fall and C_3 & C_4 are constants

$$dMdt = C_4 I \quad (3.22)$$

The drawback of this model is that it neglects all air temperature and wind effects and gives unclear ice loads [25].

3.7 THE GOODWIN MODEL

This model assumes that all the drops fall on the conductor freezes and the growth mode is dry.

$$dMdt = 2RWV_i \quad (3.23)$$

Where R is the radius of iced cylinder, W is the liquid water content in the atmosphere and V_i is the impact of drops, that is the speed it hits the cylinder with Mass per unit length M at time t , equals $\pi\delta_i(R^2 - R_0^2)$, where R is the radius of the iced cylinder, R_0 is the radius of the cable and δ_i is the density of accreted ice. Substituting for M

$$dRdt = WV_i p_i \pi \quad (3.24)$$

Integrating (3.23) gives the radial ice thickness $\Delta R = R - R_0$ accreted in a period t ,

$$\Delta R = WV_i t p_i \pi \quad (3.25)$$

The drop impact speed is

$$V_i = V_d^2 + V^2 \quad (3.26)$$

Here V_d is the fall speed of the drops and V is the wind speed. It's assumed that the wind is perpendicular to the cable axis. The liquid water content W can be related to the depth of liquid precipitation H_g measured during the accretion time t by

$$P_w H_g = WV_d t \quad (3.27)$$

Where P_w is the water density, Inserting (3.25) into (3.26) gives,

$$\Delta R = WV_d t p_i \pi + VV_d^2 \quad (3.28)$$

By inserting equation (3.27) into (3.28) gives

$$\Delta R = p_w p_i H_g \pi + VV_d^2 \quad (3.29)$$

Equation (3.29) gives correct analytical solution for radial ice thickness which includes the assumed radial ice shape[25].

3.8 CHAINÉ AND CASTONGUAY MODEL

This model also assumes that all falling drops freezes on the cable, but considered an elliptical ice form and the cross sectional area of the ice deposit S_i will be,

$$S_i = \pi R_0 (2H^2g + H^2v) \quad (3.30)$$

Here H_v is the water layer thickness on the vertical surface that is: $H_v = WV_t/\rho_w$. Chainé and Castonguay, define a correction factor K as the ratio of the real cross-sectional area and the one calculated from (3.30). Then they compare S_i with the radial ice section, that is a circular cross-section with the area S_i , and display the corresponding radial ice thickness is,

$$\Delta R = R_0 K (2H^2g + H^2v) + R_0^2 - R_0 \quad (3.31)$$

K is shape correction factor that is determined empirically by data in Stallabrass and Hearty (1967) as a function of R_0 and air temperature T only. Experiments in Stallabrass and Hearty (1967) were carried out at very high velocities and liquid water contents and with smaller drops than those characteristics of freezing rain. Now if we take real shape of cylinder then insert Equation (3.29) and by applying V_t and V, solved from the definitions of H_g and H_v , into Equation (3.29) gives

$$\Delta R = \rho_w \rho_i (2\pi H^2g + H^2v) R_0 \quad (3.32)$$

Comparing this solution for a cylindrical deposit with the elliptical concept result in Equation (3.31) and defining $H = H^2g + H^2v$ results in

$$\rho_w \rho_i H \pi = R_0 K (2H^2g + H^2v) + R_0^2 - R_0 \quad (3.33)$$

Now solving K in Equation (3.33) gives

$$K = \frac{\rho_w \rho_i H \pi}{R_0 (2H^2g + H^2v) + R_0^2 - R_0} \quad (3.34)$$

Now if we set typical glaze ice density of 0.9 g/cm³ in Equation (3.34) results in

$$K = 1.4 + 0.25HR_0 \quad (3.35)$$

OR

$$K = 1.4 + 0.25Wt\rho_w(V_d + V)R_0 \quad (3.36)$$

We can see that cylindrical ice accretion, the shape correction factor K in the Chainé and Castonguay method depends on all the relevant parameters, that may affect the icing process as well as on ice density. Especially in Equation (3.35) shows that K relies on effective ice thickness H. This can also be explained as the methods depend on ice thickness from an equation that includes a constant that depends on the ice thickness itself. And thus the method

of Chainé and Castonguay is logically incorrect. The severity of the problem in practice can be calculated by changing the ice thickness H in Equation (3.35). Suppose for $R_0=10$ mm and $H=5$ mm the correction factor is $K=1.53$, and for $R=10$ mm and $H=50$ mm it is $K=2.65$. For larger cable diameters, the change in K with H is smaller. However, in the case of other real ice shapes, K may vary more [25].

3.9 MODEL FOR FREEZING RAIN ICE LOADS

Suppose rain is falling without wind, then the drop trajectories are vertical and perpendicular to the horizontal ground, if the same amount of rain falls on a narrow sidewalk and nearby wide highway. When we have freezing cold temperature on flat highway then the water does not runoff and builds a uniform layer of ice. Now if the density of ice ρ_i is 0.9 g/cm^3 , a 10-mm rainfall results in an equal 11-mm thick ice layer. The mass of ice on a 100-m length of the highway is substantially greater than the mass of ice on a 100-m length of the sidewalk, but the ice thickness is equal. Now we can consider a long cylinder of different diameters suspended horizontally above the ground under same weather conditions. For cylinders that do not have circular cross sections, like angles, tees and rectangular tubing, the uniform ice thickness is proportional to the ratio of the dimension of the cylinder cross section intercepting the rain to the perimeter of the cross section. The 10 mm of rain that falls on the sidewalk and highway also falls on each of these cylinders. If all the impinging water freezes and it freezes in a uniform radial accretion. Then this 10 mm of rain is spread uniformly as ice over the exterior of the cylinders. Since the perimeter is a factor of π greater than the cylinder diameter, the uniform radial ice thickness R_{eq} on each horizontal cylinder is:

$$R_{eq} = 10 \rho_0 \rho_i / \pi = 3.5 \text{ mm} \quad (3.37)$$

Here $\rho_0=1.0 \text{ g/cm}^3$ is the water density. Since the ice accretes equally around the cylinder, the ratio of the diameter of each iced cylinder to the perimeter to its cross section remains $1/\pi=0.32$ throughout the freezing rain storm and the ice thicknesses on the cylinders are independent of their diameters. However, during freezing rain storms, there is always wind present and we have to include the flux of windblown rain perpendicular to a vertical surface related to liquid water content to precipitation rate, $W=0.067P^{0.846}$, here P is the precipitation rate in mm/h and W is the liquid water content of the rain-filled air in g/m^3 . Then, the flux of water perpendicular to a vertical surface is VW ($\text{g/m}^2 \text{ s}$), in which V is the wind speed in m/s. The water flux w through a surface normal to the drop trajectories is resulted by changing to a

consistent set of units and adding vectorially the contributions from windblown rain and falling rain $P\rho_o/10$ ($\text{g/cm}^2 \text{ h}$)

$$W = 0.1P\rho_o^2(0.36VW)^{21/2} \text{ g/cm}^2 \text{ hour} \quad (3.38)$$

Now the uniform radial ice thickness on a circular cylinder is:

$$Req = N\rho_i\pi P\rho_o^2 + (3.6VW)^{21/2} \text{ mm} \quad (3.39)$$

Here N is the number of hours of freezing rain with precipitation rate P (mm/h) and wind speed V (m/s)

At weather stations, the precipitation rate and wind speed are usually measured hourly and can be written as

$$Req = 1\rho_i\pi \sum_j = 1NP_j\rho_o^2 + 3.6V_jW_j^{21/2} \quad (3.40)$$

Here P_j , $W_j=0.067P_j^{0.846}$ and V_j are the precipitation rate, liquid water content and wind speed, respectively, in the jth hour of the storm lasting N hours. This equation shows that the uniform radial ice thickness in the simple model is independent of cylinder diameter and depends only on two meteorological parameters: precipitation rate and wind speed. The model relies on two empirical bases: (i) liquid water content in rain linked to the precipitation rate by Best's formula (ii) ice density formed by freezing rain is 0.9 g/cm^3 . In Figure 14 we can see for precipitation rates up to 10 mm/h and wind speeds up to 14 m/s [26].

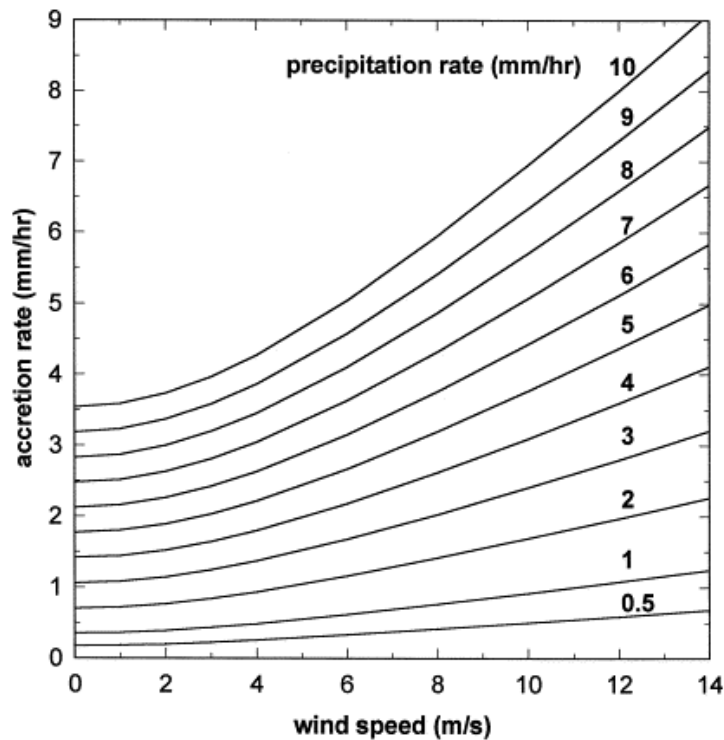

Figure 14: Uniform radial ice accretion rate for the simple model as a function of precipitation rate and wind speed [26]

Table 2 shows Conceptual evaluation of the models for conductor icing in freezing precipitation.

MODEL	TYPE	INCLUDES WIND EFFECTS	INCLUDES TEMPERATURE EFFECTS	INCLUDES ICICLES GROWTH	LOGICALLY CONCEIVED AND APPARENTLY ERROR FREE	DESIGNED FOR OPERATIONAL USE FOR POWER LINE	EXPECTED PREDICTIONS IN MODERATE CONDITIONS	EXPECTED PREDICTIONS IN EXTREME CONDITIONS
Imai	Analytical equation	Yes	Yes	No	Yes	Yes	Poor	Poor
Lenhard	Empirical Equation	No	No	No	No	Yes	Poor	poor
Goodwin et al	Analytical equation	Yes	No	No	No	Yes	Good	Fair
Chainé and Castonguay	Semi-empirical equation	Yes	Yes	No	No	Yes	Fair	Poor
Lozowski et al.	Pseudo time-dependent numerical mode	Yes	Yes	No	Yes	No	Model not designed for operational power line icing prediction	Model not designed for operational power line icing prediction

Makkonen	Time dependent numerical model	Yes	Yes	Yes	Yes	Yes	Good	Fair
MRI	Time dependent numerical mode	No	Yes	No	No	Yes	Poor	Poor
MEP	Time dependent numerical model	Yes	Yes	No	No	Yes	Fair	Poor
Finstad et al.	Time dependent numerical model	Yes	Yes	No	Yes	Yes	Good	Poor
Szilder	Analytical/random-walk model	No	Yes	Yes	Yes	No	Model not designed for operational power line icing prediction	Model not designed for operational power line icing prediction

Table 2: Conceptual evaluation of the models for conductor icing in freezing precipitation [25]

CHAPTER 4

CONSTRUCTION OF TRANSMISSION NETWORK

Electrical power is delivered via transmission and distribution network from generation point to thousands of consumers. Figure 15 shows Finnish power distribution network. We find that Finnish electricity network is divided into three levels: the transmission grid, regional networks and distribution networks. The transmission grid supply power via two lines, 400kv and 200kv lines followed by 110kv lines that supply power to industrial sector and further step down to supply power to consumers via distribution transformer and low voltage network of (0,4 kV). In Norway the bulk supply of transmission grid voltage is 420,300, and 132kV. And the total length is approximately 11000km that is maintained by Statnett [15][16].

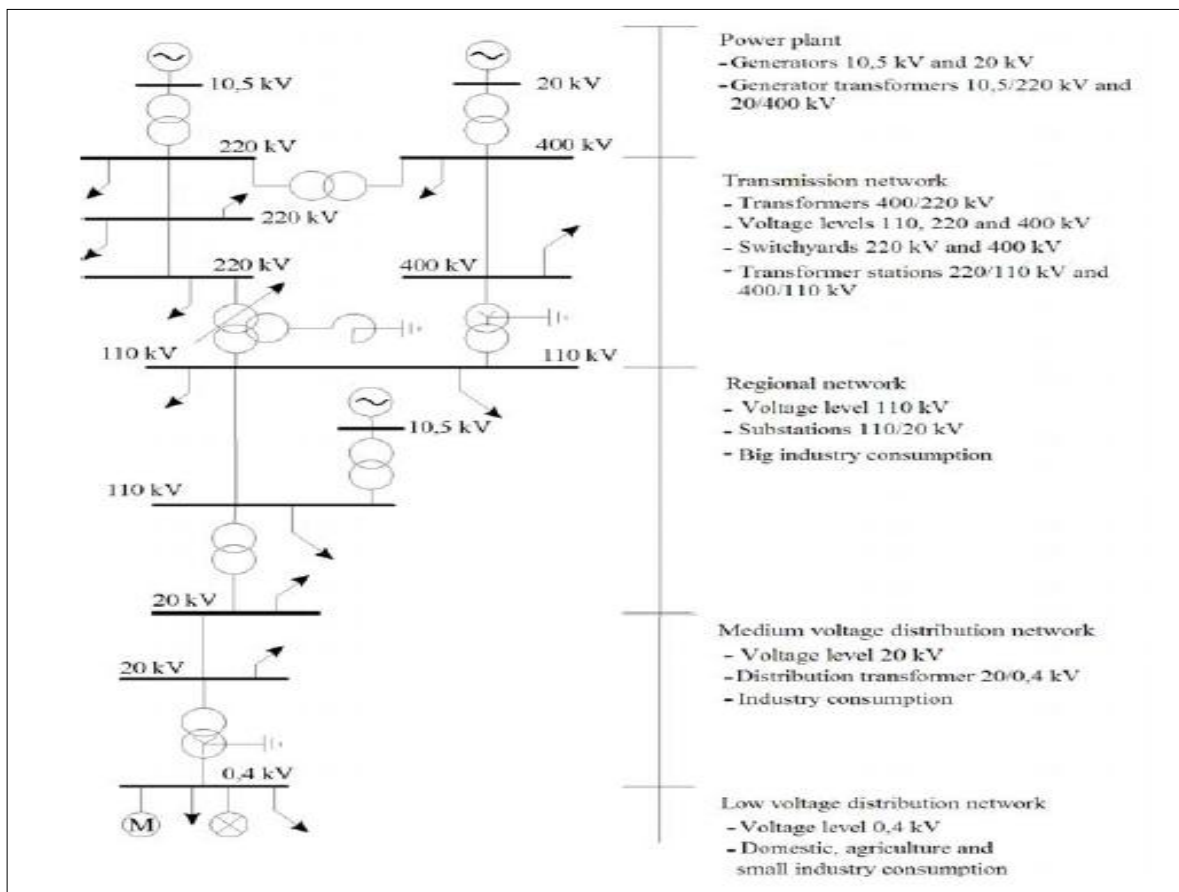

Figure 15: Power transmission/ distribution of Finish electricity network [16]

4.1 OVERHEAD LINE COMPONENTS

There are three main components of overhead transmission line regardless of voltage carrying capacity. First one is tower that holds overhead line conductors, second is insulators that

ensure the electrical insulation of the conductors and third is conductors that carries and transfers the energy. In Figure 16 basic components of power line.

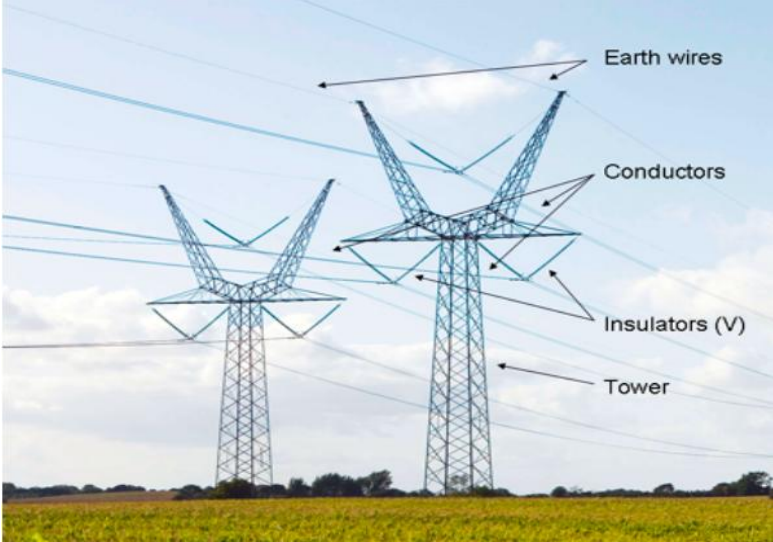

Figure 16: Over Head Power Line Components [18]

4.1.1 Insulators

The main function of insulator is that, its cuts the path of electrical power towards tower and same time holding the conductors. One can find different types of insulators for example suspension insulators are made up of different materials (i) composite long rod insulator (ii) glass cap-and-pin insulator (iii) porcelain long rod insulator. See Figure 17 [18].

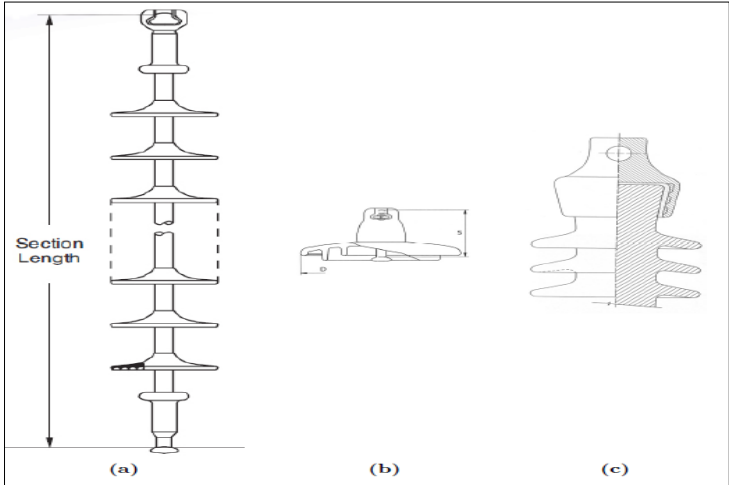

Figure 17: Suspension insulators based on different materials (a) composite long rod insulator (b) glass cap-and-pin insulator (c) porcelain long rod insulator [18]

The very first insulators that were available were made up from porcelain mounted on metal arm followed by glass insulators. Those were also mixture of other materials like glass, steel

and fillers. In 1970s, fiberglass rod insulators were widely used and are best known for their resistance against pollution, light in weight and good performance against vandalism that can cater voltage up to 765 AC.

4.1.2 Conductors

Conductors are the current carrying part of overhead line network. There are two types of composite conductors that are widely used (i) ACCR (aluminum conductor composite reinforced) and (ii) ACCC (aluminum conductor Composite core) conductors. Both conductors have good prosperities compare to ACSR (aluminum conductor steel reinforce) conductors. But behave differently like composite based conductor have low thermal expansion and high E-modulus and has an advantage of low sag and can easily withstand temperatures around 200c and also referred HTLS (high-temperature low sag) conductors. Conventionally ACSR (aluminum conductor steel reinforce) conductors are used at transmission line as well as in distribution networks and in form of cables also.

The main difference between ACCC/ACCR to ACSR conductors is for the TW strands which is the high amount of aluminum that is present in the same size of the diameter of conductors and have an advantage of low resistance, but increases the weight that influences the sag of in the conductors. The stiffness of the two conductors is much better to compare to ACSR conductors and thermal expansion coefficients of the two are also lower than ACSR conductors. That results in lower elongation under heating of the ACCC/ACCR conductors. Also due to the high content of aluminum in the TW conductor, the heat capacity of the conductors will be higher than to round wire conductors and is an important factor under loading changes on overhead line conductors. Figure 18 shows different types of conductors [18].

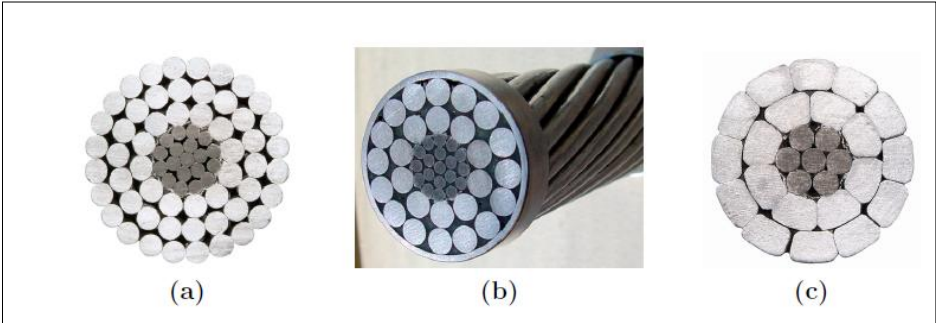

Figure 18: Aluminum Conductor Composite Reinforced (ACCR) Type Conductor, (A) ACCR Cross Section, (B) ACCR, (C) ACCR-TW [18]

4.1.3 Towers

Towers are used to carry conductors in overhead line network and use to keep them at safe distance from each other and humans. Mostly towers are made-up of steel and sometimes concrete and in lower voltages wood are also used as towers. The fiberglass poles installed first time in 1960s in Hawaii, and lasted for 45 years and they are widely used for transmission level. Composite based towers have been also used for many years and can be used for middle transmission level and high voltage levels up to 110kv by reinforcing with concrete towers, having rods based in composite materials [18].

4.2 EFFECT OF ICE AND SNOW ON THE TRANSMISSION LINE CONDUCTORS

4.2.1 Wake Induced Oscillation and Aeolian Vibrations

Transmission lines are mostly running in the open environment and are subject to winds pressure on the conductors. That includes wake-induced oscillations and aeolian vibrations. The adverse effects of such vibrations are that, it reduces the lifespan of conductors and its related accessories. However, using damping devices and spacers can be useful for increasing their lifespan. As icing on the conductor increases, the effect of aeolian vibration and wake-induced oscillations also increases. Furthermore, aeolian vibration of conductors coated with ice may occur in such frequency range that is unmanageable by damper capabilities. Galloping is also other factor that is wind-induced instability, that occurs in ice accreted conductors in both single and bundle conductors. The effects of ice on wake-induced oscillations only occur in bundle conductors with sub conductors arranged one after the other in the direction of wind. So, when sub-span oscillations that are over the wind velocity. Then the conductor span in the wake of an upstream may be excited to oscillate, typically in an elliptical orbit.

Wake- induced oscillations are mostly linked to spacing of diameter ratio of the bundle, and the sub-span length with number of spacers in each span and the angle of attack or tilt of the bundle. As numbers of spacers are useful against wake-induced oscillations, significant amount of snow on sub conductors will increase aerodynamic force acting on the leeward conductor to a point where significant sub-span oscillations could happen. Aeolian vibrations are linked with the pressure fluctuations induced by the wind on the surface of conductors. As the vortices are shed in the wake-induced, such pressure fluctuations are present regardless

the conductors are in motion or not and aerodynamics of such types of motion is commonly represented by the Reynolds number.

Reynolds numbers (Re) is given by $Re = \frac{Vd}{\nu}$ where V is wind speed, d is diameter of conductor, and ν is the kinetic viscosity of air. Aeolian vibration on the transmission lines generates multiple sinusoidal waves between the spans and its frequency ranges from 3 to 150Hz. Its aptitude may reach to the magnitude of conductor's diameter at the anti-node of these waves. Ice and snow will affect Aeolian vibrations through different mechanisms and snow layers could smooth terrain obstacles that may normally contributes to wind velocity fluctuations which reduce the turbulence of the wind. Icing on conductors could lock the conductor strands together that results in conductor's internal damping through strand slippage decrease. The ice weight increases conductor's tension that will decrease conductors self-damping. Aeolian vibration is generated by the cracking of vortices alternately from the top and bottom of the cable. Increase in aeolian vibration power can be result of damper fatigue failure in power lines. When overpowered, the dampers may result in larger amplitudes, capable of inducing fatigue in the dampers themselves. It was concluded that aeolian vibrations under icy conditions may result in fatigue problem. To overcome such problems Hydro-Québec Canada installed new spacer damper that can withstand ice loads under sever ice storm conditions. Performance tests showed in the laboratory span and full-scale test line, and measurements on a transmission line have shown that the Hydro-Québec damper is good enough as a Stockbridge damper for reducing the aeolian vibrations on a conductor. Below we can see Stockbridge damper in Figure 19 [3][19].

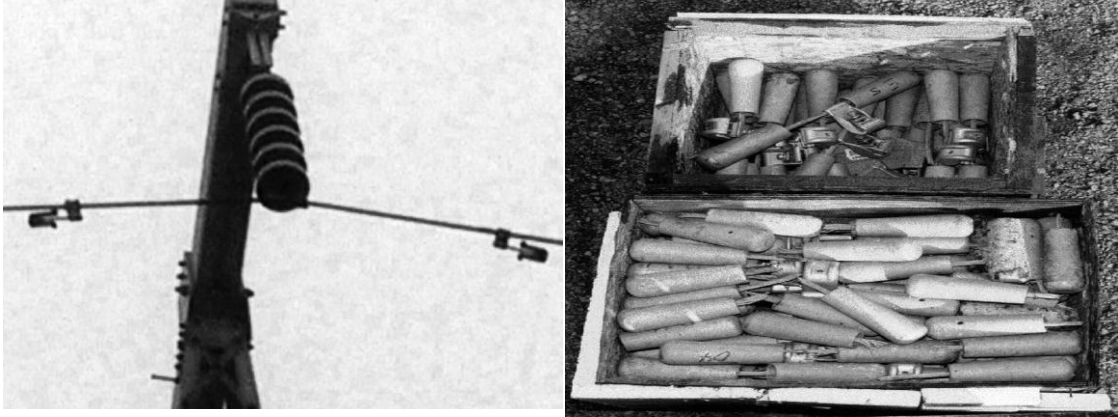

Figure 19: Stockbridge dampers with missing masses on a transmission line L- side and Stockbridge dampers damaged during galloping tests R-side [19]

Galloping in transmission line can be seen as excitation in the span, in which icing is present. An aerodynamically unstable movement as the conductor oscillates, the angle of apparent wind flow attack on the ice section results in aerodynamic forces. Thus producing to and fro motion in vertical direction in the conductors. Galloping amplitudes can reach to cable sag, that can result in flashovers. And these amplitudes also generate dynamic forces in the span that are transmitted to the towers through the suspension hardware. Large galloping could happen at the first natural frequency in the span approximately 3 Hz. Wind velocity of the speed of 10 km/h is required to generate galloping and the severity goes up with the wind speed up to 60 km/h for transmission lines. Minimum wind velocity is required generating galloping and depends on system damping. Galloping of transmission lines is one of the most disturbing events caused by ice accretion and wind hitting the conductors. This event produces large amplitude vertical motions, when wind hits the conductors covered with ice.

Ever since the introduction of vertically oriented double-circuit power lines, we have witnessed flashovers between adjacent phases. Peak-to-peak galloping amplitudes up to 15m have been recorded and Galloping can have line tripping as a result of phase to phase contacts. In addition, there may be mechanical damage to the conductor's hardware and supporting structures. Galloping mostly happens at temperatures between -5 to +2. Since such temperatures are considered most conducive for wet snow or freezing rain. Also occurs at lower temperatures when ice accretion remains on the conductor and temperature is dropping. It was observed in Serbia under -50c at high amplitudes, conductor's flashovers are common problems caused by galloping. When it occurs, automatic protection system disconnects the circuits, until the cause of fault removed and repaired. There also reported cases of broken conductors. Figure 20 shows galloping in conductor [3].

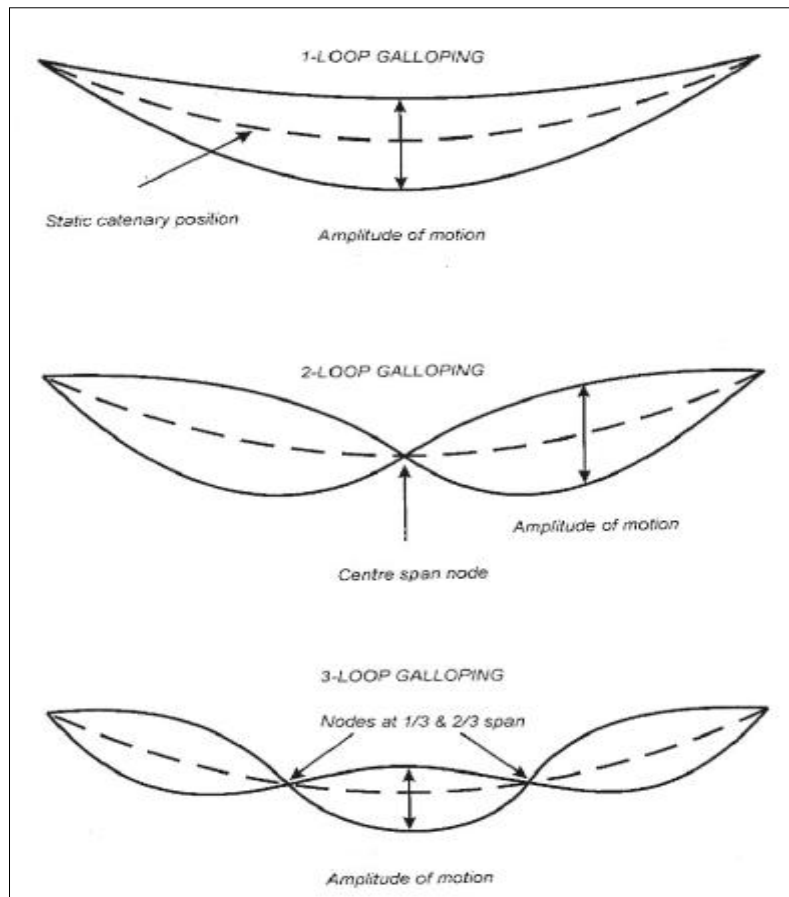

Figure 20: Galloping types in overhead lines [3]

The other drawback of galloping is that it induces dynamic stress and load from the conductor to the towers and its supporting hardware's every time galloping occurs. Such action also affects the supporting structures. It's reported that vertical loads applied to the tower arms with its supporting hardware and insulators was increased twice against static vertical load with ice on the conductor, and it was also reported that the horizontal loads applied to dead end or strain structure can be as high as 2.8 times the static tension in the conductors. Since such stresses and loads are not normally added into the structure design and are mostly assumed to be covered by other extreme loadings. As heavy ice loads and maximum wind load. Moreover, the loads acted during galloping events are repeated several times and required to be referred to endurance against fatigue, opposed to the static strength of the components.

The most regular outcome of such dynamic loads is tower bolts loosening, and fatigued bracing members, and in most rare event tower arm bending. And main member breakage has also been reported. Where clamp-top insulators are used, cement failure of the porcelain insulators as a result of bending movement has also been noticed. As well as damage to the

insulators recorded during galloping. When insulator string hitting tower arm and long twinned or multiple suspension strings are used on lines with large diameter conductors at high voltages. Most often the insulator strings can undergo extreme oscillations within their length. This result in string hitting each other and damage the porcelain or glass sheds.

To prevent flashovers, one useful way is to install interphase spacers, that are considered very useful against flashovers due to galloping and ice loads. We can see in Figure 21.



Figure 21: Interphase spacers on transmission line [3]

One of the advantages of interphase spacers is that they are very effective even when the conductor is still galloping. It was observed that displacements and the resulting dynamic loads were high but amplitude motion was very low and it was reduced up to 27%. In the beginning interphase spacers were made of porcelain insulators but the latest spacers are made of lighter polymer insulators and mostly 3 to 4 interphase spacers are installed between two towers [3].

4.2.2 Ice Shedding

Ice shedding may have same outcome as galloping. It requires high dynamic load on the lines that may results in tower arm breakage and damage to other towers connected to the line. As the conductors rebound, it comes close to other conductors, ground wire and other parts of towers and if the line crosses road network, it brings extra hazard as chunks of ice may fall on vehicles. It is not a continuous exercise but once the ice falling starts, the conductors may be excited for several cycles with low amplitude where the damping is mostly due to the air resistance over the conductor displacement. Ice shedding is a difficult activity to observe since it happens abruptly and is not continuous compare to conductor galloping. It was concluded that interphase spacers are useful to minimize movement of conductors from hitting each other due to ice shedding and the lateral clearance must be sufficient to allow for the possible rotation of the lower conductors around the middle conductor. There has to be good clearance between phases and between phases to ground wires between one to two meters. This increased clearance is also useful against galloping. Interphase spacers can also be used in this case. They are located in the middle span because the first span mode is usually excited when the ice sheds on the whole circuit. De-icing at an early stage of the ice precipitations to avoid heavy ice shedding is also useful but rarely practiced due to the difficult steps in the process [3].

CHAPTER 5

ICING MONITORING SYSTEM

As the problem persists, there are several methods to monitor ice buildup from sensors, cameras, visual inspection, drones, small helicopters etc. In this session we put light on some of the method practiced at present.

5.1 ICE BUILDUP MONITORING VIA METEO

EGÚ Brno in cooperation with electrical power companies has been involved in solving the problems of icing of overhead lines. In late 90s they installed first prototype for measuring ice buildup called Meteo and later on device installed with new features. As the equipment process metrological data that affects reliability of overhead power lines. Device also made use of sensors that evaluate and process data and then transfer to superior system through GPRS and on ground via Ethernet and SCADA system with numbers of warning messages. For example, foreign intervention into the monitoring equipment, outage of supply and its restoration exceeds the set up ice mass value, exceeding the set up steepness of ice growing and exceeding the value of wind velocity. Figure 22 shows Meteo installed on power line.



Figure 22: Meteo with Support arm and sensors [20]

Meteorological data, measured by Meteo can also be used for other problems such as heavy wind that pose threat to the network and falling branches from trees. It processes data from pyranometers that can be used for calculating energy produced by photovoltaics in different regions. Also the recorded data can be further examined for designing new network that includes ice loading and weather patterns. This information about ice loads can then be used for further analysis of icing maps and standards for designing overhead lines. PMS

(Meteorological monitoring station) are usually connected to its SCADA System (Supervisory Control and Data Acquisition) that collects the data for further decision making. Figure 23 displays working principles and when icing starts, the dispatcher decides based on present ice load and the latest situation on how to deal with the event and when to start the line for heating [20].

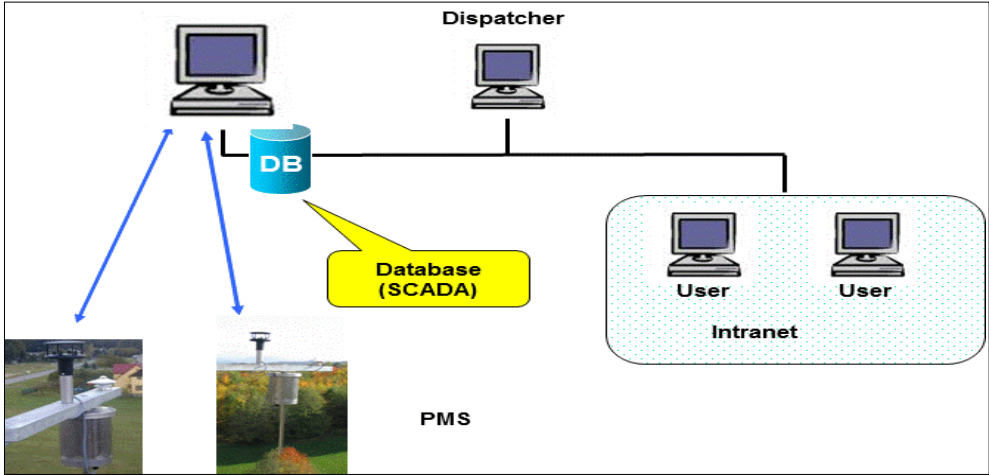

Figure 23: Scheme of Processing Data Measured [20]

5.2 ICE BUILDUP MONITORING EXPERIMENT IN ITALY

In Italian electrical network, every year heavy wet snowfall causes winter blackouts on high voltage and medium voltage lines. Estimated loss in revenue is greater than 200 million Euros. To overcome this problem, an ice predictive system was developed called WOLF (Wet-snow overload alert and forecasting), which is based on RAMS Regional Atmospheric Modeling System, WRF Weather Research and Forecasting and the wet-snow accretion model based on Makkonen for the estimation of snow load and sleeve thickness on cylindrical conductor. In Figure 24 we can see that scheme of all measurements collected at the experimental station and it shows different observation like: photos of the wet-snow occurrence by two web-cameras, mechanical stress calculations on conductors exposed to snowfall: weight, size, diameters of ice sleeve and electronic measurements related to the control of the anti-icing current and principal meteorological parameters as air temperature, wind speed and its direction, snow accumulation, snow water equivalent of precipitation and physical calculation and depiction of the snowfall as well as droplet size, snowflakes velocity and particles numbers. The WOLF experiment carried out at WILD Wet-Snow Ice Laboratory Detection and the site is located in the west part of the Alps in the municipality of Vinadio.

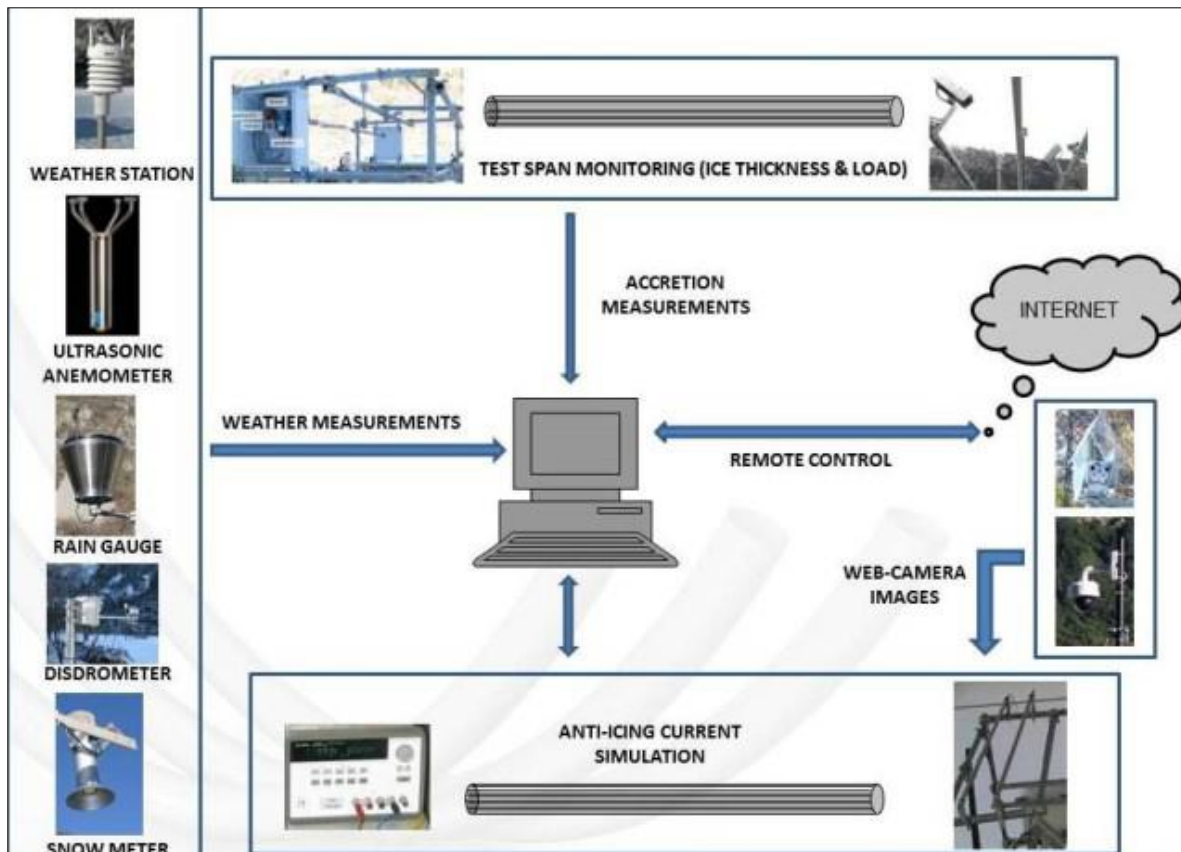

Figure 24: Scheme of all measurements collected at the experimental station [12]

Two pieces of ACSR conductors with a length of three meters have been installed on a system that allows them a slow circular motion, according to ISO12494. The rotary motion is compulsory for two reasons. First due the circular motion, system is able to capture well the total flow of snowfall and this permits accurate comparison with the simulated values received by the accretion model. This assumes a conservative growth on conductor. Secondly, at the center of the span of overhead line, the weight of snow sleeve can have a little rotation of conductor. One piece of ACSR conductor is covered with a hydrophobic coating. The other ACSR conductor is weighed through two load cells placed under them and two ultrasonic sensors calculate the thickness of snow-sleeve during the wet-snowfall.

In Figure 25 below, we can see setup of ACSR (aluminum conductor steel reinforced) conductors and sensor settings [12].



Figure 25: ACSR Conductors Subjected to Slow Rotation (L-Side) and Measure the thickness of Snow Sleeve. ACSR Conductors Intended for the Simulation of AI Current (R-Side)[12]

Two conductors of 1.5 in length of ACSR Ø31.5mm are used for the simulation. Skin temperature of two conductors set to 1°C and 1.5°C. The simulation of AI current is allowed by a resistance wire inside each conductor that will generate a Joule-effect up to 40 W/m as shown in Figure 25 to keep the skin temperature at the set points in all time. A PC displays minute to minute surface temperature calculated by thermal sensors, and maintains the power sent to the conductors by a programmable power supply. The wet-snow load on the rotating ACSR conductor were calculated around 2.7 kg/m with a diameter higher than 30 cm for the first event and an accumulation of 5 kg/m with a diameter of 25 cm for the second one. The new conductors having hydrophobic varnish on surface gave unsatisfactory results. However, the Joule effect simulation on the two ACSR conductors displays that the circuit is capable to de-ice cables from snow buildup and maintaining the surface temperature of conductor around to 2°C. It is clear that the successful simulation of wet snow accumulation highly relies on accurate atmospheric input data, and accurate wet-snow model [12].

5.3 ICE BUILDUP MONITORING ON INSULATORS

Freezing rain and heavy snow also bring insulators icing. If the phenomenon last longer, it may pull down the transmission line and that compromises the safety of power network. Therefore it's very important to recognize the situation of insulator icing on time and

accurately. So that in difficult situation quick solution of transmission line insulators icing can be mastered in a real-time manner in order to evade accident.

The recognizing technology of insulator icing on the transmission lines via image processing method and mechanical analysis method. That display the icing and online monitoring method for transmission line icing based on 3D recognition, to improve the accuracy of icing on conductor. An algorithm of morphological closing operation quotient image is used to examine insulator image that can overcome impact of complex environmental cycles and calculating ice thickness of insulator with accuracy in timely manner. By gray scaling image, the effect of color depth variation on the wavelet domain and its inverse transform image is avoided and upgrading image recognition speed and minimizing computational time. By locating point of a color in the RGB space, the projection of the origin to the point vector is calculated and the gray value of the color is obtained, r, g, b components are shown by 8 bits, the value range is [0,255] and gray value calculation steps are in Figure 26 below [21].

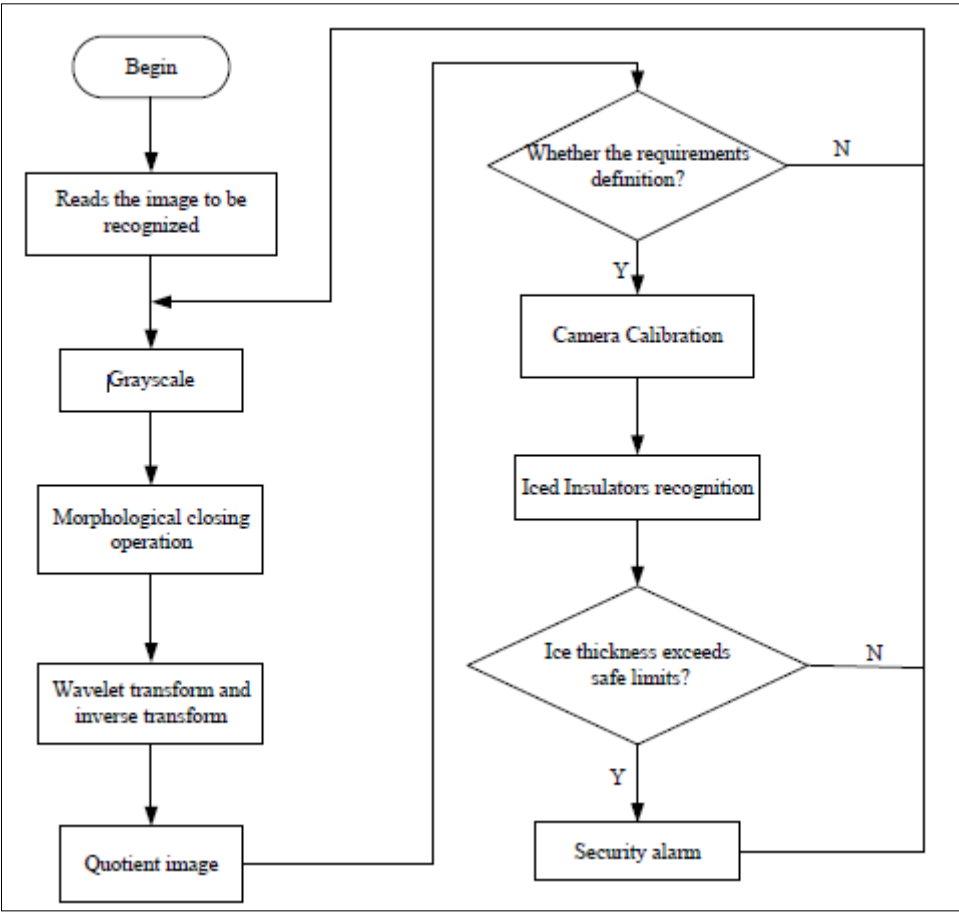

Figure 26: Image Recognition Algorithm Flow Chart [21]

The formula below, (r, g b) shows the coordinate vector of a color in the color space, (255,255,255) by showing the vector of the diagonal in the color space.

$$Y = \frac{(r,g,b) \cdot (255,255,255)}{(255,255,255)} \quad \text{OR} \quad Y = \frac{r+g+b}{\sqrt{3}} \quad (5.1)$$

According to the formula above Y= insulator icing pictures on the location of a foggy day, sunny day and cloudy day, we can see in Figure 27.

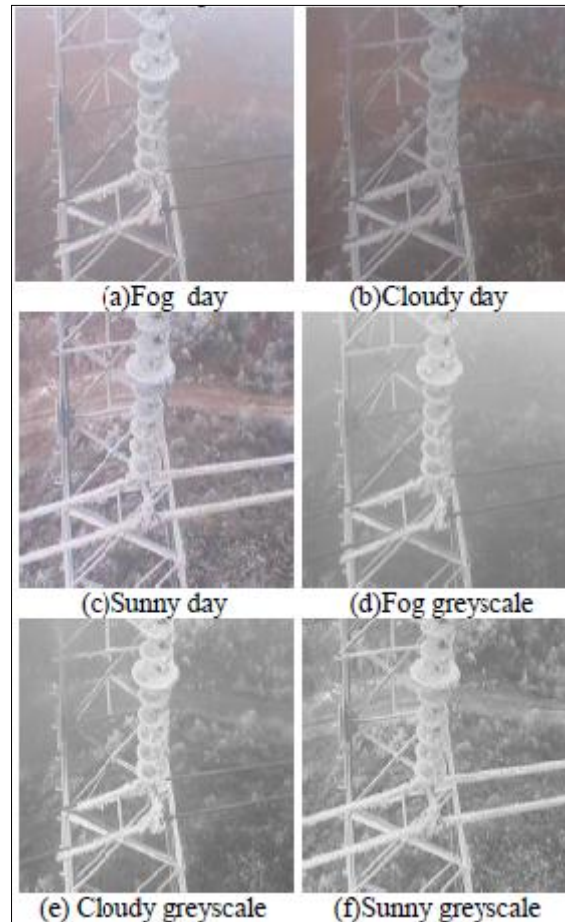

Figure 27: Grayscales Comparison Pictures [21]

The color of each pixel in the insulator's picture is decided by R G B three elements and each element has 255 values, and a pixel can have the changing range of 255^3 colors. After grayscale sorting the pixel points of the changing range of image is minimized to 255. By sorting the images into processed and unprocessed, the same as color image, the gray image also shows the distribution and feature of an image's whole and local color and intensity level precisely. The color's intensity information of the insulator image is deleted by grayscale sorting, minimizing the amount of the original data, diminishing the amount of the follow-up calculation remarkably. Test were carried out in artificial simulate iced laboratory in indoor

condition and simulated at a humidity of temperatures under sunny, cloudy, foggy and snowy. Four types of conditions of insulator icing observed in real time. The thickness of the ice through experiment calculated through an algorithm. The thickness of the iced insulator can be recognized accurately by the algorithm. Maximum relative error of the thickness of the iced insulators in the four cases is the snowy day 4.8 %, and the lowest is the sunny day, only 1.5%.

This completely displays that the algorithm of this experiment can be used for all types of complex environment, and can recognize the ice thickness of insulator accurately. We can see in Figure 28 below ice experiments [21].

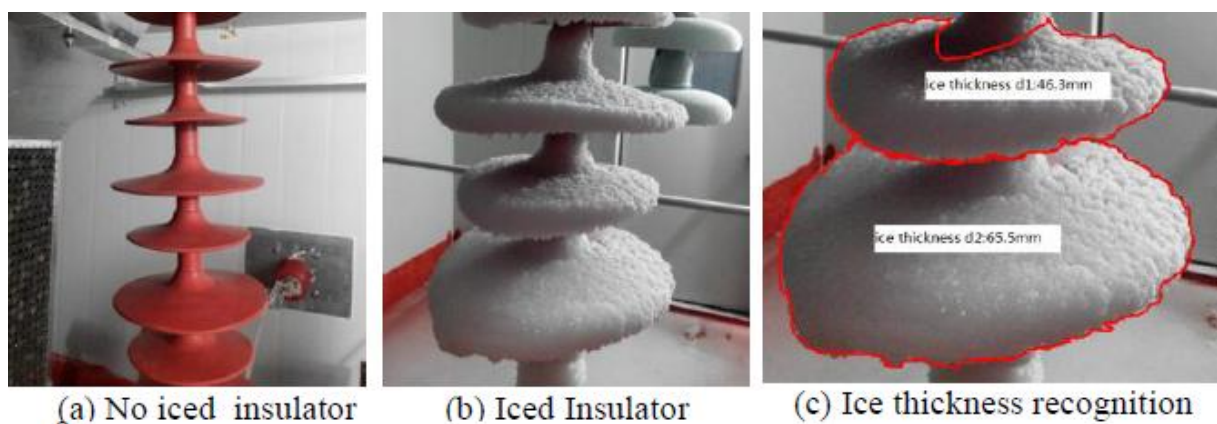

Figure 28: Ice Recognition Experiment [21]

5.4 ICE BUILDUP MONITORING VIA RADAR

Sensing pulse displays from any available heterogeneous wave resistance by the end of line has information about appearing ice deposits in radar detecting system. Ice formation on the wires shows as heterogeneous dielectric and minimizing the motion of a signal along the line causes additional attenuation. Due to dielectric losses of electromagnetic wave energy, that is consumed in heating of ice layer coating. Radar system allows examining the ice buildup on a transmission line by differencing the time propagation of signal reflection having different amplitudes, showing when ice is present and when it's not. Examining the line with pulse radar (reflectometer), numbers of the reflected pulses forms a trace.

The ice formation on the conductors shows change in trace as high as the impedance feature of the line will change under the ice formation changes of dielectric constant, between the wires of the line. The increase pulse delay Δt and decrease pulse amplitude U . The following steps followed in radar sensing technology of ice deposits formation for power transmission line. (i) Trial traces are taken and digitally processed to examine the required signal from

noise in control line and software module “attenuation” is used. (ii) The length of line is determined by using impulse reflect meter. Attenuation in line is measured to determine the amplitude of sensing source impulse. Figure 29 gives results of attenuation of signals in high frequency tract of lines with length of 16 630 m and 45 700 m. According to given results of attenuation. The amplitude of radar sensing output signal is measured. This gives reliable and accurate detected impulse reflected from heterogeneity of the line, with oscillation background in High Frequency tract of Power Transmission Line.

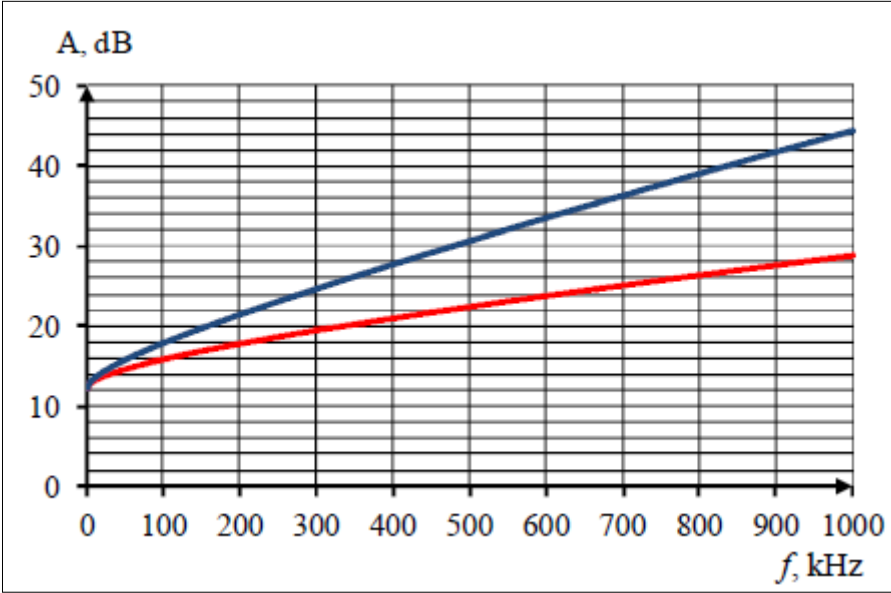

Figure 29: Relation of attenuation with frequency in High Frequency tract, Lines with length of 16 630 m (red line) and 45 700 m (blue line) [22]

The calculation in Figure 29 is wide assumptions that cannot be taken as real in explaining complex process like spreading radar sensing impulses via short band transmission lines. Most importantly displaying errors between the calculated and actual values that are pointed out during formation of rime-ice deposits on line. More accurate values of attenuation of each High Frequency tract can be point out separately and in combination using specific software. But calculation of frequency response of High Frequency tract experimentally is not always possible. In such cases, modeling of High Frequency tract of Power Transmission line with special packages such as Matlab Simulink gives more accurate values of measurements [22].

5.5 SENORS FOR ICE CALCULATION

We can find atmospheric icing sensors that can detect icing event, type of ice, ice load measurement and icing rate. Such sensors can further be connected to Anti/Deicing system. Power requirements for the removal of snow and ice are different. And to distinguish between

snow and ice can be considered a limiting factor for de-icing systems. The ability of sensor to calculate ice load with high accuracy and to overcome ambient conditions may give false results. Atmospheric ice can be calculated by direct and indirect methods. As in indirect method, we take into consideration humidity and temperature that result in icing. In Direct methods of ice and snow detection based on the principle of detecting property changes due to accretion such as mass, dielectric constants, conductivities, or inductance. There are currently at least twenty-four direct measurement methods using different techniques like: Hybrid Measurement Technique, Impedance Measurement Techniques, Infrared Energy Measurement Techniques, Axial Load Measurement Technique, Microwave Energy Measurement Techniques, Capacitance Measurement Techniques, Ultrasonic Energy Measurement Techniques, and Resonance Measurement Techniques.

5.5.1 Capacitance Measurement Techniques

In capacitive sensor an electric field is used to detect the presence of dielectric material, these attributes enable non-invasive calculation. The electrical properties can measure ice thickness and temperature. For dry snow, the dielectric constant is determined by the density. For wet snow the imaginary part and the increase of the real part due to liquid water, have the same volumetric wetness dependence.

5.5.1.1. Capacitive Ice Sensor by Weinstein

The sensor proposed by Weinstein can be used to calculate ice thickness on the outer surface of sensor, and is independent of temperature and type of ice. The sensor has first capacitive gauge, second capacitive gauge and temperature gauge. The geometry of first and second capacitive gauges is such that the ratio of voltage outputs of first and second capacitive gauge is proportional to the thickness of ice, regardless of ice temperature or composition. This ratio is determined by offset and dividing circuit. In figure no 30 we can see construction of Weinstein sensor [60].

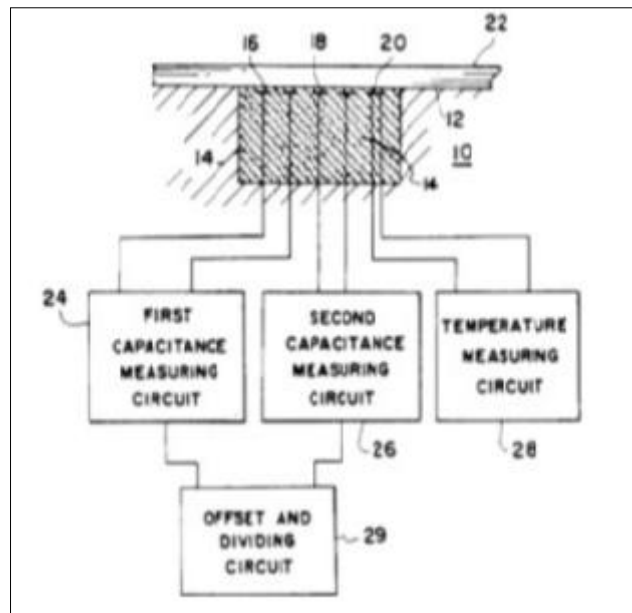

Figure 30: Construction of Weinstein Ice Sensor [60]

5.1.1.2 Capacitive Ice Sensor by Jarvinen

The sensor design by Jarvinen can detect ice, its type and thickness. Dielectric properties of ice and snow give different variations when A.C is applied to it. Jarvinen used this method for detecting ice accretion by first measuring the properties of the contaminant layer overlying the ice sensor using variation in Cole Plot. And compare the measured outputs for the magnitude and shape with laboratory data taken at the same temperature and stored in the processor. It is possible to differentiate between ice or rain water or deicing fluid or snow. Such differences, if found to exist, are used to correct the initially chosen ice thickness value based on the assumption of normal ice: ice with no flaws, cracks or voids or higher electrical conductivity [60].

5.5.2 Ultrasonic Energy Measurement Techniques

Most of the ultrasonic ice sensors are made of two transducer elements, in which one element generates ultrasonic vectors, which is detected by the other element. By calculating attenuation levels, icing between the two elements can be detected. Ultrasonic sensors consume low power, low cost compare to capacitive sensor, and are directionally sensitive.

5.5.2.1 Ultrasonic Ice Sensor by Luukkala

In this sensor a mechanical ultrasonic signal is send along a thin thread or strip at one end and the intensity of the ultrasonic signal having passed through the thread is calculated at the other end. If the thread is under water drops, then ultrasound will not be activated, and if the water drops freezes, the ultrasound cannot propagate in the thread, but will be abruptly attenuated. If the thread is covered with a sludge, the ultrasound will be somewhat gives a pulse of a kind of intermediate level, at which detection of sludge is also possible. A viscosity difference exists between ice and water, and thus the intensity of the ultrasound having passed through the thread will also be different. These ultrasonic sensors are made of a measuring transducer. A thread-like or tape-like acoustic waveguide having an ultrasonic transmitter at one side and ultrasonic receiver at other side and a device that consists of electronic components for calculating the intensity and the attenuation of an ultrasonic signal having passed through the transducer thread in the case of ice accumulation [60].

5.5.2.2. Ultrasonic Ice Sensor by Watkins

The ultrasonic sensor by Watkins is comprises of two ultrasonic transducers. The first transducer is energized to cause propagation of ultrasonic waves through a portion of a solid metal sheet along its predominant part, parallel to the surface of the sheet and detecting the waves by means of the first ultrasonic transducer, while recording the amplitude of the waves received by the second transducer on the surface. In case of ice layer on the surface, the amplitude and intensity of the waves calculated by the second transducer will reduce, as waves having their predominant component parallel to the surface will dissipate energy into the ice layer. But it is considered that it will not dissipate energy into air or liquid. The waves may be horizontally polarized, guided shear waves, or the waves may be a mode of lamb wave, whose predominant components are horizontal. The transducers may be attached to the other surface of the portion of the sheet to which an ice layer may create, and could generate and receive by piezoelectric or electromagnetic means. Figure 31 shows the design of Watkins sensor [60].

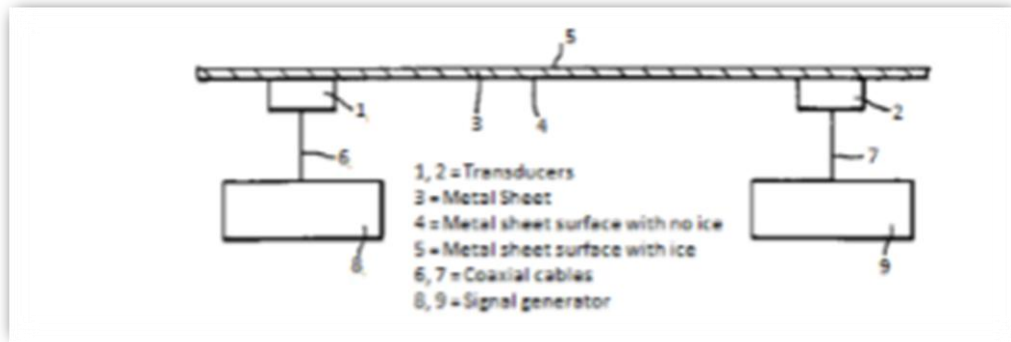

Figure 31: Design of Watkins sensor [60]

5.5.3 Resonance Measurement Techniques

As the name say in such sensors there is an element which vibrate as a result of ice or any mass that interact with vibrating element. These ice sensors are a single point ice detection device. That delivers information about the presence of ice and cannot distinguish between the types of icing.

5.5.3.1. Resonance Ice Sensor by Cronin

This ice sensor works under the principle of magnetostriction that can be described as the ability of ferromagnetic materials to change shape under the influence of a fluctuating magnetic field. This sensor delivers a binary signal. When ice accretes on the probe, the vibration frequencies change due to the increase in mass [60].

5.5.3.2. Resonance Ice Sensor by Koosmann

In this sensor a vibrating element in a tube moves along the longitudinal axis of the tube. This tube is linked to an excitation coil at its natural frequency and is concealed by a diaphragm. The surface exposed to an air stream to which icing is to be sensed. The exposed diaphragm surface is deflectable during movement of the tube at a flexible support portion of the diaphragm. As ice accumulates on the exposed surface the natural frequency of the cylindrical section changes which indicate ice buildup. The diaphragm is of low mass and small size, so that the stiffness of small amounts of ice can change the spring constant of the flexible element [60].

5.5.4 Microwave Energy Measurement Techniques

This method uses waveguide in which microwave energy is used to cross through a substance using waveguide and the reflected energy can be computed to deliver information of ice buildup.

5.5.4.1. Microwave Ice Sensor by Overall

The icing-sensor can sense the presence of ice/ water on a road or other surfaces. These detectors microwaves are transferred via a waveguide to the underside of a window substantially transparent to the microwaves and installed substantially flush with the surface to be observed. The presence and thickness, within reasonable limits, of any coating of ice deposits on the surface of the window is calculated by measuring the amount of microwave energy reflected by the window. The reflected energy can be used to inform ice presence [60].

5.5.4.2. Microwave Ice Sensor by Magenheim

This ice sensor is equipped with a device to generate microwave electromagnetic energy, transmitting the microwave energy on the layer of ice. The microwave energy reflected from the ice layer is used to calculate the relative amount of ice present on the layer. Microwave electromagnetic energy (usual frequency falls 2 k – 20 k MHz). That sends to the surface of ice, and the reflection or impedance characteristic of the ice layer are calculated [60].

5.5.5 Impedance Measurement Techniques

In impedance measurement technique, the saturation of the electrodes can be minimized and data points can be increase in this technique. The impedance based ice sensing technique and capacitive measurement technique are very much alike. The only differentiation between the two is the source of information is one used current and other uses voltage to deliver information.

5.5.5.1. Impedance Ice Sensor by Seegmiller

The Impedance Ice Sensor by Seegmiller is useful to show parameters such as ice buildup and ice load for a wide surface. The sensor has voltage detector, temperatures sensors, inductive ice sensing electrodes, frequency generator, resistance bridge and a processing unit. The inductive ice sensing electrodes is mounted on the surface of interest and consists of a transmitting electrode (minimum one receiving electrode). The electrodes are insulated to minimize any false calculations due to conductive substance or electrolytes. The coefficient of coupling between the sending and receiving electrodes is calculated by at least two factors.

The first is the preset geometry and distance between the electrodes and the second being the inductive coupling susceptibility of the ice in the general region of the spaced apart electrodes. This susceptibility is indicative of the presence and ice thickness. The device for calculating temperatures is mounted onto the surface. The frequency generator delivers an excitation signal and has means for being connected to the transmitting electrode of the inductive ice sensing array. The voltage detector has means for being linked to the receiving electrode of the inductive ice sensing array and detects a proportion of the supplied excitation signal to the transmitting electrode as a function of the coefficient of coupling between the sending and the receiving electrode. The voltage detector delivers a resulting signal showing the thickness of adhering ice, frost or water substance in the general region between the spaces of electrodes [60].

5.5.6 Infrared Energy Measurement Techniques

In this technique we measure the amount of light that is reflected from the surface via absorption and reflection of active infrared light by the ice.

5.5.6.1. Holo Optic Ice Sensors

HoloOptics has working element that is consists of an infrared emitter with a single head, two head or four head recorders, a photo detector and a probe. The operating range of this sensor lies in the Near Infrared Radiation NIR range (0.88 μm to 0.92 μm). An icing event is calculated, when more than 95 % of the probe is covered with a 50 \times 10⁻¹⁰ m thick layer of glaze ice or a 90 \times 10⁻¹⁰ m thick layer of other types of ice. Once icing is detected, the probe heating system is activated to melt the ice buildup. Deicing dependent solely on the icing rate and heating power is provided. The time lapse between icing events is used to determine the icing rate below we can see HoloOptic ice in figure 32 [60].

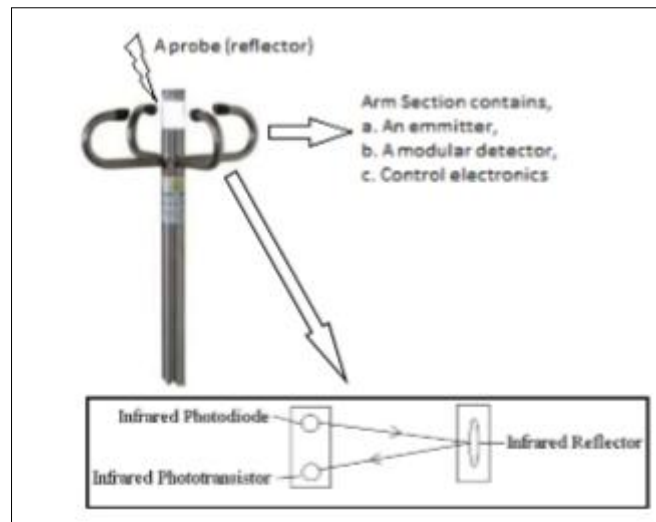

Figure 32: T44 Holo Optic ice sensor [60]

5.5.7 Axial Load Measurement Techniques

This technique uses an axial load having strain gauges. Also, it is mentioned in ISO 12494 that for calculation of icing load. A slowly rotating steel rod that is at least 0.5-meter-long (or 1 meter if heavy icing is observed) and has the diameter of 30 mm. This long length of steel rod because too heavy icing is probably aimed to uniform drag distribution along its profile. Two ice sensors (ice monitor & ice meter) have been designed according to ISO recommendations. However freely rotation works on the basis of axial load measurement technique.

5.5.7.1. Ice Monitor by Combitech

The Ice Monitor is developed by SAAB Technologies is for surveillance of power lines, and can calculate ice rate via load cells. But has a limitation that it is unable to detect ice over a wide area and cannot distinguish between the two types of in-cloud icing. The Ice Monitor is made in accordance with ISO 12494 standards and calculates the mass of accumulated ice gravimetrically. It has a freely rotating steel pipe of 50 cm in length resting on a rod of 3 cm diameter, placed on a load cell. When ice accretes on the freely rotating steel pipe, the ice load is calculated by the load cell. When ice accretes on the steel rod, aerodynamic drag will cause it to rotate in the case of free rotating icing technique, always facing the least amount of the iced part towards the wind. We can see this in figure 33 [60].

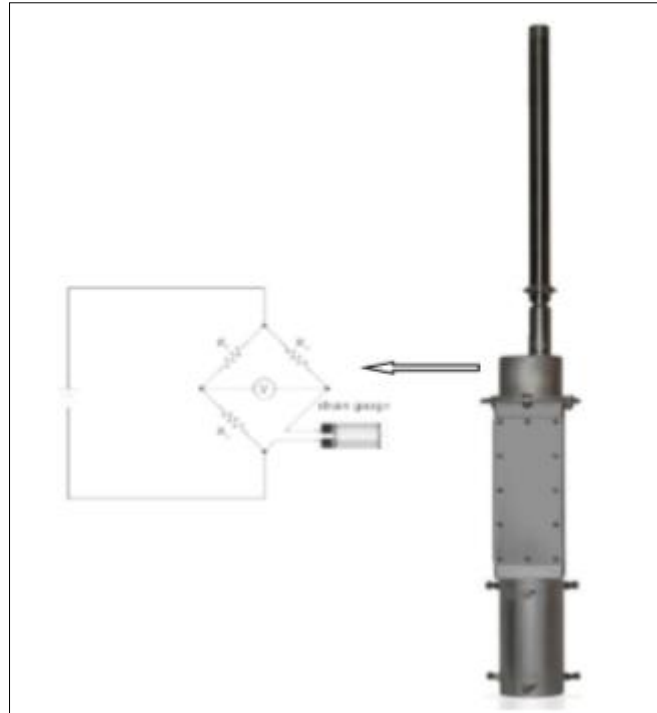

Figure 33: Ice Monitor by Combitech [60]

5.5.8 Hybrid Measurement Technique

As the name suggests, this technique uses more than one ice detection techniques to get more accurate calculations.

5.5.8.1. Hybrid Ice Sensor by Jarvinen

This ice sensor can detect ice, its thickness and its type. In this technique the contaminants layer temperature, thermal conductivity and variation of total impedance versus ice sensor electrical excitation frequency are calculated. And the total impedance data is transforming to show the complex dielectric properties of the overlying layer. The calculated properties and the complex dielectric properties are useful to show the difference between rime and glaze ice by comparing the outputs with preset calculated ice data in the computer memory [60].

5.5.8.2. Remote Ice Detection RIDE System

In this technique we can calculate thickness of foggy or clear layers of ice or liquid on surfaces at distance in the range 6.5 to 30 m. The main parts of this technique are a low power laser with a long distance focusing optic, compact telescope and a digital camera.

The telescope's knob is handled by a first servomotor and a filter is used in bright sunlight atmosphere that is handled by second servomotor.

Helium Neon HeNe laser and optic for beam expansion and focusing. This optic is also controlled by servomotor, complete configuration of this RICE device can be seen in Figure 34 [60].

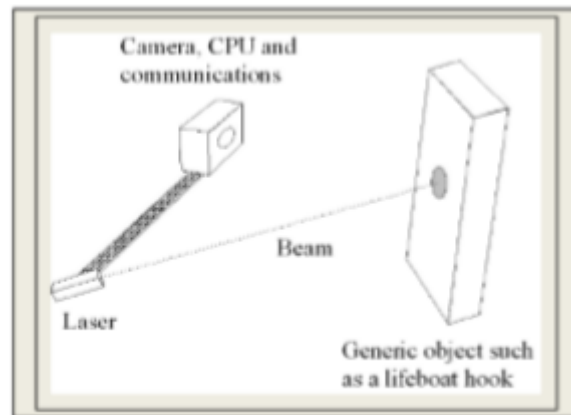

Figure 34: A configuration of miniaturized RICE device [60]

5.6 COMPARISON BETWEEN DIFFERENT ICE DETECTION METHODS

We have several ice detection methods that are useful for power transmission and wind energy systems. They are handy to provide total ice loads, icing conditions, persistence, and other information depending on which factor is most important using sensors. We can also find information regarding severity (ice load) or intensity (icing rate). Detection methods gives an indication of meteorological icing, that is duration of active ice accretion, and/or instrumental icing, that is the period of time where ice is present on a structure, instrument or an object. Modern wind energy turbines are equipped with ice protection mechanism and will activate preventive shut down, in the event of heavy icing. Both strategies are useful against ice related losses and make system cost effective. We can find several products that are available to monitor ice buildups like Ice Monitor, Goodrich, Labkotech, and Holo optics ice detectors with a camera and heater anemometer measurements. A study conducted in Canada in order to point out their pros and cons.

We can see different sensors and methods in Table 3 that are used to detect icing [23].

METHOD	SENSOR	DESCRIPTION	ICING CRITERIA
CAM	CAMERA	ICE THICKNESS FROM IMAGES OF VERTICAL ANEMOMETER SUPPORT	N/A
CIM	COMBITECK ICE MONITOR	FREELY ROTATING ISO CYLINDER WITH LOAD SENSOR	LOAD>0.2Kg/m
GID	GOODRICH 0872F	SPECIALIZE ICE DETECTION SENSOR BASED ULTRASONIC FREQUENCY CHANGE	THICKNESS >1mm
HVT	HV,T	BASED ON HORIZONTAL VISIBILITY AND TEMPERATURE CRITERIA	HV<300m T<1°C
LID	LABKOTEK LID-3300IP	SPECIALISE DETECTION SENSOR BASED ON ULTRA SONIC FREQUENCY CHANGE	SIGNAL< 60% WITHIN LAST 30MIN
LWCT	MRR & T	ATMOSPHERIC ICING BASED ON LWC MEASURED FROM MRR AND T	LWT>0.1g/m ³ @ 75m AGL T<1°C WS>4 m/s
RHT	RH,T	BASED ON RELATIVE HUMIDITY AND TEMPERATURE CRITERIA	T-0.9T _{DEW} <1°C T<1°C
WDD	WV	DETECTS ICE FROM THE VARIATION IN STANDARD DEVIATION OF WD	$\sigma_{WV} < 3$ Or: $\sigma_{WV} < 1/3\sigma_{WV(ref)}$ T<1°C
WSD	HUA,UCA	WS DIFFERENCE BETWEEN HUA AND UCA	$\frac{WS_{HUA}-WS_{UCA}}{WS_{HUA}} < 80\%$ WS _{HUA} >4m/s T<0°C

Table 3: Different Ice Detection Methods [23]

According to Table 3 that displays that the CIM LID and GID methods works on simple criteria defined to interpret the signal of the specialized ice detection sensors that is ultrasonic

frequency change. The WSD RHT and WDD methods are based on standard data quality control tests. Like in WSD works on WS (wind speed) and difference between HUA (Heated Ultrasonic Anemometer) and UCA (Unheated Cup Anemometer) and CAM method simply gives photos taken by camera installed on meteorological mast. Ice thickness is calculated on the vertical section of the boom that supports an anemometer using an automatic image analysis algorithm developed by TCE Techno Centre éolien. The camera pictures were taken every 10 minutes at low resolution since they were not supposed to be used for ice accumulation through image analysis in the beginning. We can see in Figure 35 below which shows non-iced and iced anemometer and vertical support structure. Since the direction of ice accretion on the anemometer's boom relies on the wind speed, the image analysis algorithm could not measure ice accumulation on the structure. That is why the measured ice thickness was an estimate for qualitative purposes only.

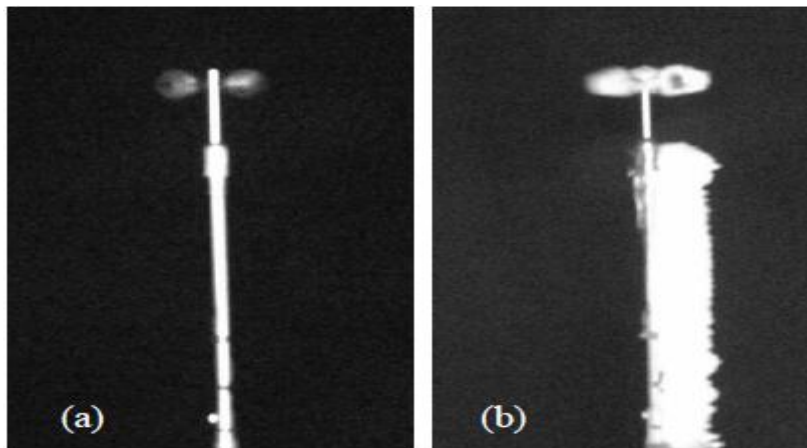

Figure 35: Cam image with ice and without ice accumulation [23]

Nine ice detection methods were examined and compared against each other for overall icing hours and for specific event sensitivity of each instrument from beginning of accretion till ice shed the following observation were recorded below:

- The LID method displays ice accretion after the heating cycle is started showing an indication of icing amount.
- The GID method also gives an indication of icing intensity as the sensor increases the frequency of heating cycles during hours of active ice accumulation.
- The HVT method gives same results as the LID but shows half the total icing hours. HVT can be taken as more reliable since the LID method was found to overestimate ice accumulation during small icing events.

- The RHT method gives plenty false positive results.
- The CAM method shows plenty information on the icing event but depends on the camera lens not being obstructed by ice. This can be managed with proper heating and protection from ice. The algorithm also depends on the quality of the picture and may not be able to point out icing when there are not sufficient contrasts in the images.
- The WSD and WDD methods provide good measurements of instrumental icing but may need to be recalibrating for low wind speeds.
- With 10-minutes average, the CIM method gives a constant instrumental icing response though its load measurement was not validated and sometimes gives negative load values.
- The LWCT method followed meteorological icing of other methods, but is useless against in cloud icing.
- The LID and GID methods calculated a high number of meteorological icing hours relative to instrumental icing hours measured with WSD and WDD methods [23].

Sensors themselves go under several operation and design stress problems, which may lead to false alarms. Some of the problems are Low temperature, which may affect electrical and mechanical properties of device. Then the electrostatic discharge problems could not be fully neglected when weather station goes down. Temperature gradients in the ice particles generate charge separation, due to the concentration of H⁺ and OH⁻ ions in ice. That's increases rapidly with increasing temperature. H⁺ ions are very much free within the ice crystal compare to OH⁻ ions. That leads to colder part of an ice particle become positively charged, leaving the warmer part charged negatively. That is dangerous for the control circuitry inside the sensor module, but proper maintenance of earthling at the site can be helpful in this perspective. Also, that helps in instantaneous power surge that may affect sensor operation. Electrical insulation of external power cables is another big issue which needs to be taken seriously. Reason is a low temperature can cause cracks, and most of the time PVC insulations cannot withstand low temperatures in the range -30oC or below. They crack and peel off in extreme temperature and results in exposed conductors. Which cause short circuiting or develop other problems such as grounding leading to make data unreliable.

Table 4 showing Compression between several atmospheric Icing Sensor Techniques and Patents [60].

Patents and Sensors	Potential Capability					
	Detection	Type	Thickness	Load Icing	Icing Rate	Melting Rate
	Capacitance Based Measurement Technique					
Weinstein	✓		✓			
Jarvinen	✓	✓	✓		✓	
Impedance Based Measurement Technique						
Seegmiller	✓					
Wallace	✓					
Ultrasonic Energy Measurement Technique						
Luukkala	False indication				✓	
Watkins	✓					
Resonance Measurement Technique						
Cronin	False indication				✓	
Kooseman	✓					
Microwave Energy Measurement Technique						
Overall	✓					
Magenheim	✓					
Infra Red Energy Measurement Technique						
HoloOptic Sensor	✓	✓			✓	
Axial Load Measurement Technique						
IceMonitor & Icemeter	✓			✓	✓	
Hybrid Measurement Technique						
Jarvinen	✓	✓	✓		✓	
RIDE	✓	✓	✓			

Table 4: Compression between several atmospheric Icing Sensor Techniques and Patents [60]

CHAPTER 6

ANTI ICING –DE ICING OF POWER LINES

Overhead transmission lines can be considered as one of the critical components in power transmission network, transferring power from generation plant to grids and substations. Since generation plants are built far from main cities. The transmission line carries extra high voltage (bulk supply) that delivers to the grid stations and the substations in the city. These lines require a routine preventive maintenance to avoid huge breakdown and keeps the system functioning. In arctic area, one can also take into consideration the extreme low temperature with heavy icing on regular basis which puts adverse effects on power transmission lines and may also lead to power breakdown. Since heavy icing effects stability and reliability of the system that results in line losses. Therefore, it is important to carryout de-icing operations in order to avoid power breakdown that can results in economic losses. A transmission line network stretches up to hundreds of kilometers, depending on the power rating, and performing daily patrolling is costly and difficult task. Also, the structural landscape makes it even difficult to carry out such inspection. In maintenance tasks, we can consider these structural landscapes as: small mountain, rivers, lakes and hills etc. A high-power demand makes it almost impossible to shut down power supply for longer periods and to carryout preventive maintenance operation. Power blackout means loss of revenue that could bring cities to a standstill. De-icing operation can also be performed on live transmission lines, due to latest technologies but extra care must be taken when carry out such operations. By making use of smart techniques that can resolve any safety issues and make it a safe operation. To carry out de-icing activities, maintenance crew required to be skilled, having good understating of the network and proper knowledge of risk involved and safety measures during operation. At present power companies also take consideration of weather predictions, along with human prediction to get a better understanding of ice accretions on transmission line. Making use of latest technologies like online ice surveillance system and remotely control ice sensor used to calculate the ice accumulation and ice data can be taken as real data on the right time using minimum resources. As such data can print a picture to evaluate the risk involved in deicing operations, before any major fault results in power breakdown. Most power lines cover long distances that feed power to the cities and even a shortest span can be measured in kilometers. In the arctic, snow formation on the line can be difficult to examine as the lines are distributed in a vast area and different conditions based on the climate. Power

companies make use of Aerial inspection method by using helicopter during regular maintenance or in the event of fault. However, such operations are expensive and can only be done during clear weather. Such operations also require highly skilled personals to do inspection, and the lines and conductors must be thoroughly inspected as the minimum height of tower in transmission line starts from approximately 65feet. Below we can see in Figure 36 showing different heights of towers according to voltages [27].

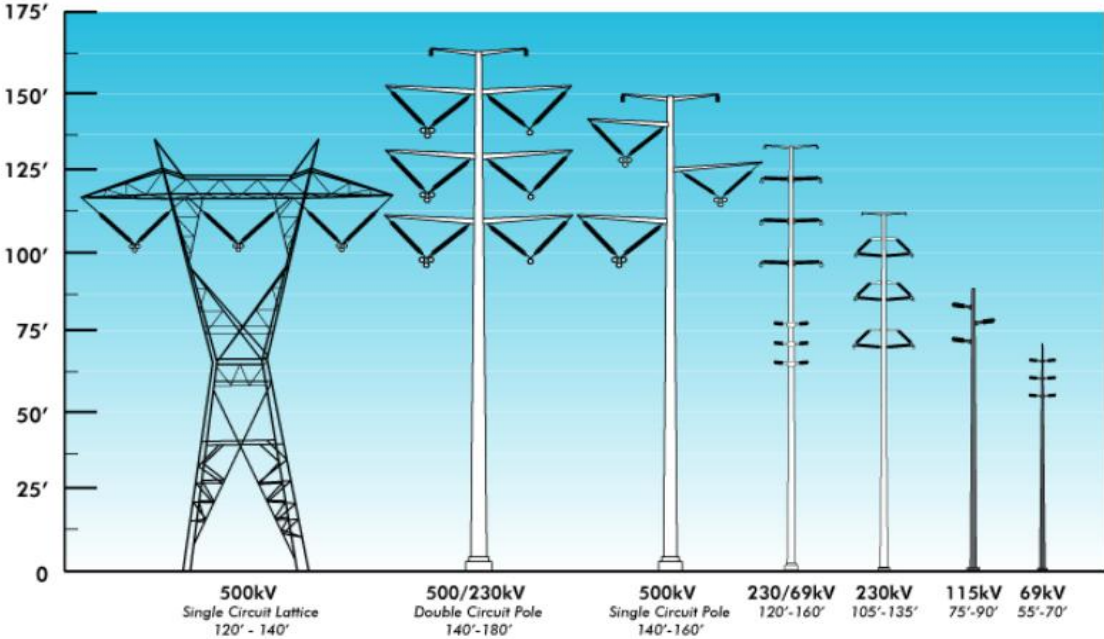

Figure 36: Transmission line circuit configurations [27]

6.1 INSPECTION OF POWER LINE

There are number of techniques to perform inspection on transmission lines and investing in such systems makes it highly reliable with minimum faults. Electrical companies are using latest techniques, such as remote inspection by making use of mobile or fixed sensor. Monitor the network through video or web data transmission. However, such technologies have their advantages and shortcoming but they evolve by time to deliver results.

6.1.1 Inspection Techniques Using Fixed Sensor

As discussed above sensor can be considered as the most important device in terms of monitoring and can give real time data to the control room to take appropriate action. In present day technology, we find different types of sensors performing number of tasks, such as: Optical Image Sensing, LIDAR Vibration Sensing, Ultraviolet Image Sensing, Acoustic Sensing Strain Sensing, and Infrared Image Sensing and Satellite Image Sensing etc. Also, sensors are small in size and can easily mount on the transmission towers for surveillance.

We can see in Figure 37 below showing different ways, how a signal can be transmitted and received [28].

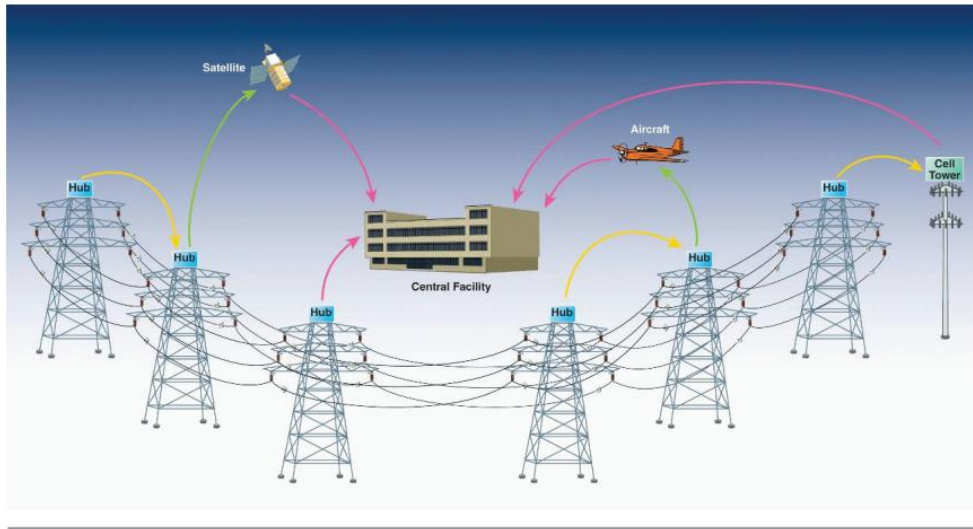

Figure 37: Data transfer from transmission tower to control room
Electrical power research institute USA [28]

In cold regions, icing is occurs frequently and effects of prolonged low temperature brings devastating effects on transmission lines such as line losses, conductor damage and short circuits faults etc. In Southern part of china, low temperature and icing have the same impact on transmission line as one could observe in arctic. They come up with solution of monitoring of transmission line. At beginning, video monitoring and observation can be made on dip-sag of line between two towers due to weight of ice. But such methods have their limitation and did not provide desired results. For reliable monitoring, they included strain sensors to monitor ice thickness, that is FBG-fiber Bragg grating sensor and that delivered good results in monitoring. Sensors are light in weight and made to withstand harsh low temperature, robust in shape and most importantly, it can give accurate three phase conductor condition and uses optical fiber to transfer data from tower to control room.FBG is basically is a type of distributed bragg reflector constructed in a short segment of optical fiber that displays a particular wavelength of light and it's based on the modulation of the reflection wavelength in response to load or temperature. We can see in Figure 38 on next page which shows central icing monitoring systems [29].

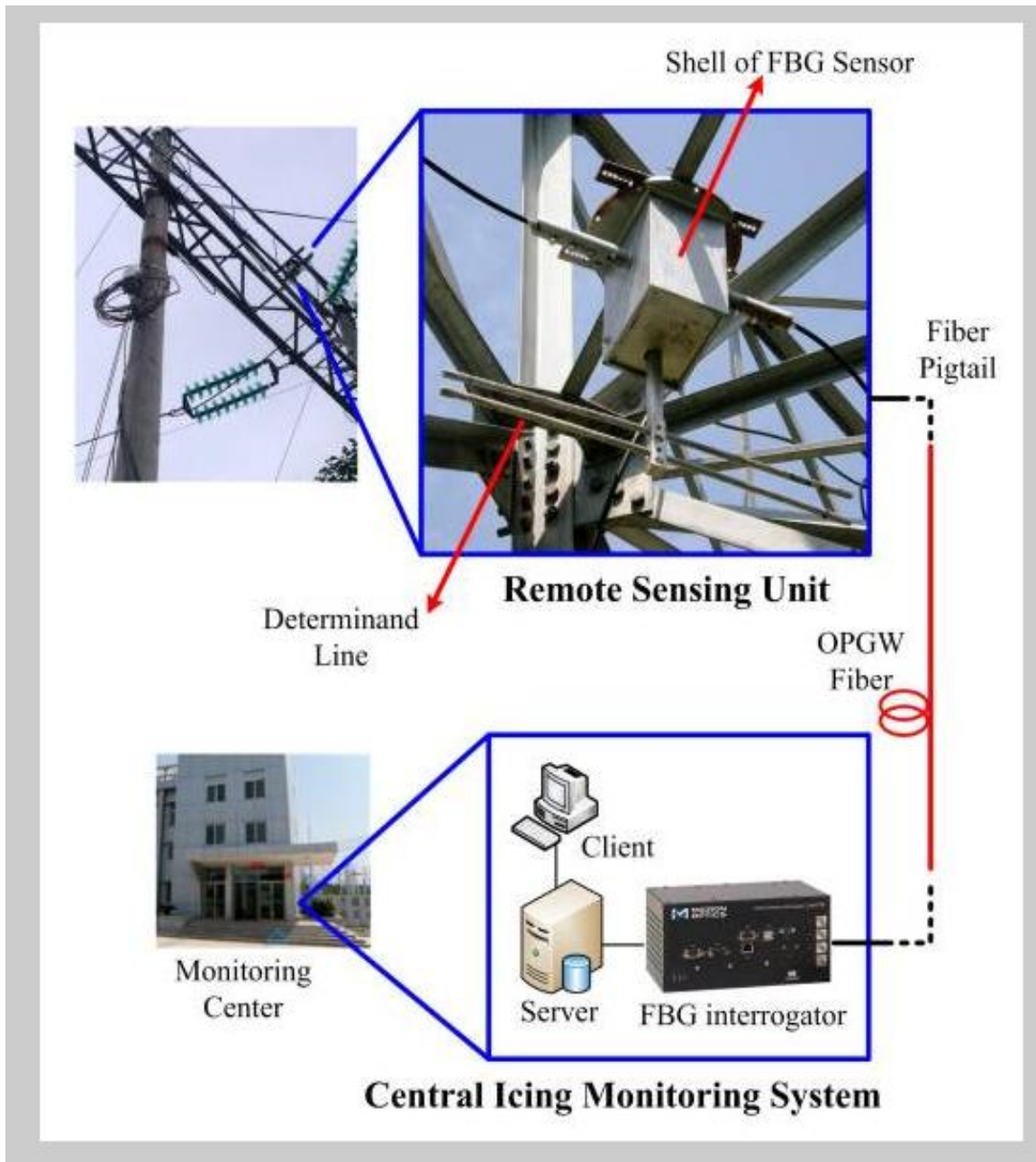

Figure 38: Central icing monitoring systems [29]

6.1.2 Inspection Techniques Using Fixed Cameras

Cameras are also useful tools for real time monitoring and bring live images to the control room. A camera can be mounted on the transmission towers, and gives direct pictures of conductors and can also record and store data. Latest cameras can zoom in and zoom out and can move both left and right, and can also give good quality pictures. Another advantage of cameras is to detect possible vandalism and monitor and record events round the clock since

they are small in size and can also run on solar cell battery charging as Figure 39 below gives an idea of camera monitoring [28].

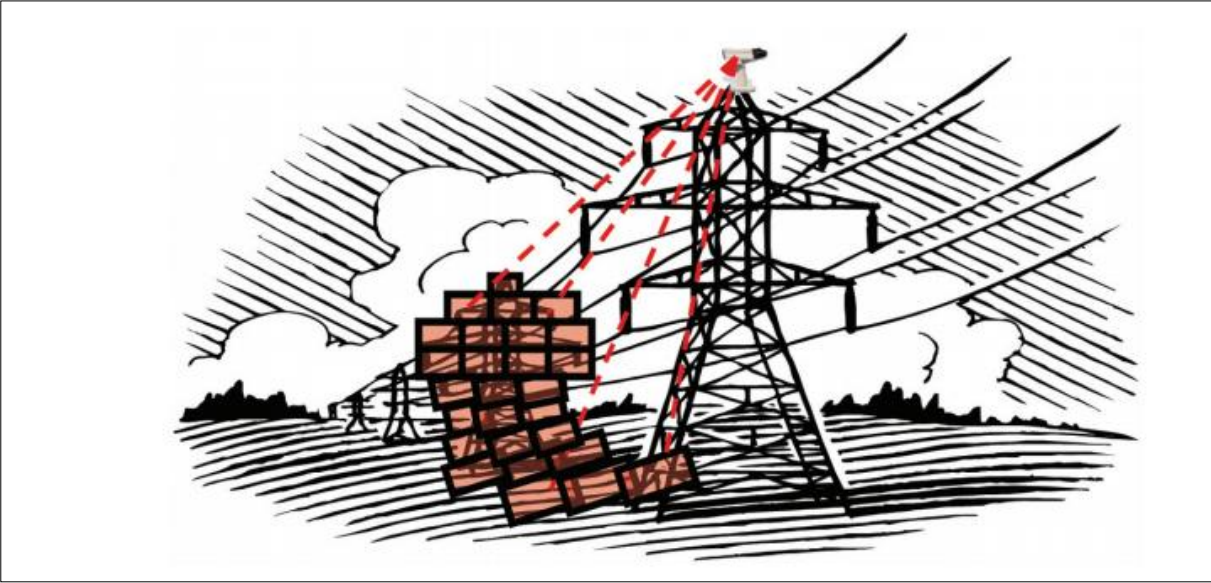

Figure 39: Camera monitoring of transmission line [28]

6.1.3 Robots for Power Line Inspection

In Japan Kansai Electric Power Company (KEPCO) comes up with semi-autonomous robot, to perform inspection of transmission lines, it's given a name “expliner”. The main purpose of the robot is to record the external condition of the conductor, to check for any corrosion, and measure the diameter. It also captures the close view of jumpers and spacers via built in camera. The other advantage of expliner is that it can manage to overcome obstacles in transmission towers as it can move over above suspension clamps, making it possible to move one tower to another.



Figure 40: Robot by Expliner [30]

As we see in Figure 40 above, the working mechanism of robot and the camera it uses that can monitor four lines simultaneously and gives GPS information. The data gathered can be automatically processed to the ground receiver. The robot is equipped with four sensors and a camera that can give up-close picture of the conductors, and it can travel approximately 1.62km/h and can also run on live lines. However at present, it can only be used when conductors have no icing but a change in design might make it possible to make it even work in arctic condition. [30][31][32][33].

6.1.4 Human Controlled Aerial Vehicles

Human controlled Aerial vehicles also known as small drones or helicopters can also be used for surveillance of transmission lines. Due to popularity of drones and its widespread uses for surveillance, it makes them a better alternative for monitoring of transmission lines. A drone can move fast and can go to long distances and get pictures of difficult terrain if transmission line passes from small hills or rivers. The latest aerial vehicles are equipped with laser cameras and sensors to get real time pictures and could potentially save half of the cost and time compared to traditional human surveillance. However care must be taken during operation and should be kept at safe distance from transmission line to avoid any accidents. Figure 41 below shows image of surveillance helicopter [32][34].



Figure 41: Surveillance helicopter-T&D world magazine [34]

6.2 DE-ICING MEASURES

Due to climate change, volatile weather phenomenon may be observed in recent times. For example, in prolonged winters, extreme low temperatures that can put extra pressure on power transmission companies to deal with adverse weather condition and workout new ways

to perform maintenance. The first step to overcome such difficulties is to make change in structure that can withstand extreme weathers and prolongs low temperature. De-icing can be achieved either by ice melting (thermal effect) or mechanical methods can also be adopted during heavy snowing and low temperature. This method requires heavy ice load prevention, which prevent transmission line from ice adhesion. This can be achieved by using anti-adhesion chemical that can melt the ice, and these chemicals have direct effects on transmission lines.

In general de-icing can be achieved in four ways

- Active ice-phobic coatings.
- Mechanical methods based on breaking down the ice.
- Passive methods based on natural forces or physical geometry.
- Thermal methods of ice melting.

6.2.1 Passive Methods

In passive method, we rely on natural forces to shed the ice on power transmission lines, examples are: wind, solar, and gravitational force, such techniques are useful to reduce ice accretion. This method can be used when we need to prevent the formation of wet snow ice on the conductors. There are few ways to achieve it such as: To weaken ice adhesion buildups and stopping freezing of highly cooled water droplets during icing by making use of either natural force like wind and gravity or making use of combination of both to limit the impact. Since highly cooled water droplets make ice. But ice adhesion on surface has direct impact from outer temperature or external surface energy, and lower surface energy can separate ice from surface (conductor) and then gravitational force effect the ice. In past, industrial viscous liquids such as greases, industrial oil and other lubricants were used for weakening ice adhesion on transmission conductors.

However such lubricants have short life and are required to be applied regularly on transmission lines and should go under shutdown to carry out such operation [35][36][37].

Material	Surface free surface energy (mN.m ⁻¹)
Poly (tetrafluoroethylene) or PTFE	20
Poly (dimethylsiloxane) or PDMS	22
PVDF	25
Polystyrene	33
Nylon 6,6	46
Copper	60
Liquid water	72
Silica (dehydrated)	78
Anatase (TiO ₂)	92
Iron oxide (Fe ₂ O ₃)	107
Aluminum	>100
Steel	>100
Rutile (TiO ₂)	143

Table 5: Surface free energies for different compounds [37]

In Table 5 above, we can see that material that have lower surface energy than water, can be considered having low ice adhesion strength, and can be used as an air contact surface coating to weaken ice adhesion. Ideally, there are two basic methods that can be used for making Ice phobic coatings. The first one is mixture of icephobic coatings from compounds of low surface energy such as Poly-tetrafluoroethylene and Poly dimethyl siloxane. In a long-run, PTFE coatings resulted as an effective tool for weaken of wet snow accretion, but still not known for atmospheric ice.

The second approach is the use of heterogeneous polymer coatings as an ice-reducing factor and this heterogeneous polymer can be obtained by mixing poly siloxane and fluorocarbon compounds. This can be a better approach than the first one as it can provide a much higher ice reduction factor than the first one [37] [38][39][40].

The other passive method that works against snow buildup is called “snow ring”. It is a small ring that has a cylindrical shape that can be connected to a conductor under snow accumulation and its counterweight is used to minimize the wet snow accreting on power lines. Snow accreted on transmission line forms into cylindrical-sleeve in two different ways. Either the snow accretion could slide down along strands of line and develops in to cylindrical-sleeve or the line can be twisted and the accretion develops in to cylindrical-sleeve

snow. The snow ring prevents a snow from sliding along strands of a wire and lets it drop off the wire to minimize snow buildup on span. We can see snow ring in figure 42 [36][41][42].

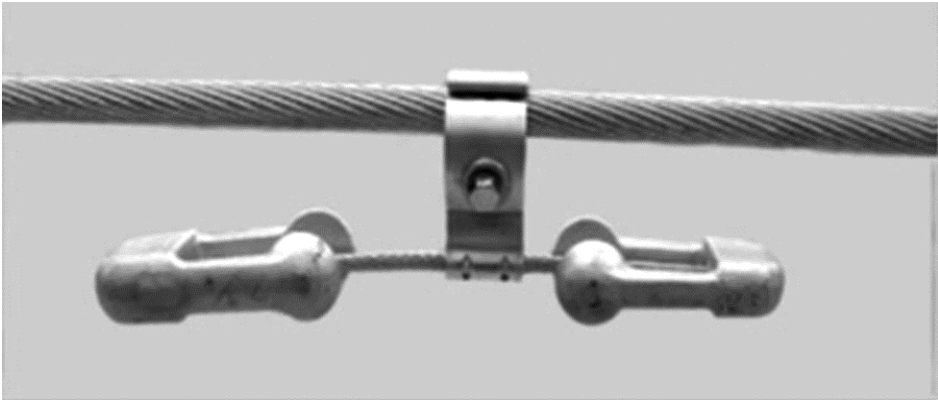

Figure 42: illustration of counterweight on transmission cable [43]

6.2.2 Active Ice-Phobic Coatings

In this method, the conductor has additional dielectric coating from ferroelectric material that keeps the conductor temperature above freezing point. However, these coatings can only be applied at manufacturing phase and cannot work on existing network. Also, such coatings have a short life of 5years and require high AC frequency of 60 kHz for deicing. Since the standard frequency used is 50 or 60Hz in service voltage and higher frequency can affect the conductor life directly that results in line losses. Figure 43 shows conductor with LC Spiral rod. In Japan, ferromagnetic heating method has been used called LC-spiral rods, and was quite satisfactory against wet snow accumulation on transmission lines by using different wrapping angles, its temperature can be adjusted in winter and in summer[36][44][45].

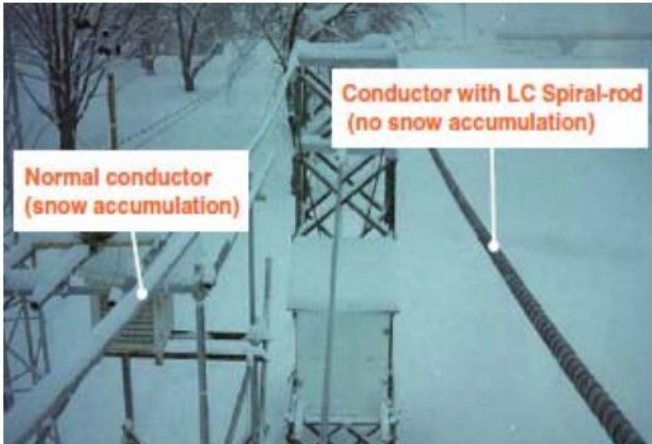

Figure 43: Snow melting conductor [36]

6.2.3 Mechanical De-Icing Method

Mechanical methods can be subdivided into several methods, adopted in different regions examples are:

- Scraping methods.
- Shock wave methods.
- Vibrating devices.

It works on simple basic principle that is to apply mechanical force either by human or instrument that sheds the ice off transmission lines and if we compare it to thermal method it requires 100,000 times less energy. The prime advantage of this method is its relative ease of operation since mechanical methods are quick and easy to implement. But if lines are passing through small hills and rivers then it could become difficult to perform de-icing. Figure 44 below shows mechanical method for de-icing [36][46].



Figure 44: Mechanical method for de-icing [36]

There are number of devices that were developed as an automatic line-vibrating device, but most of them were unpractical for long term. Currently, the most practical vibrating or shock wave method is motioning the transmission line using 90kg weight knotted rope to remove accreted wet snow. Normally it is estimated 50% of wet snow on 500m line could be removed within half an hour. In the recent past, a device called ice-shedder was also used for shedding the ice. The device has a motor that runs on unbalance weight and vibrates in the natural frequency of the span which results in ice shedding. The motor speed can be regulated according to ice accumulation. Figure 45 below demonstrates working mechanism of ice shedder [35].

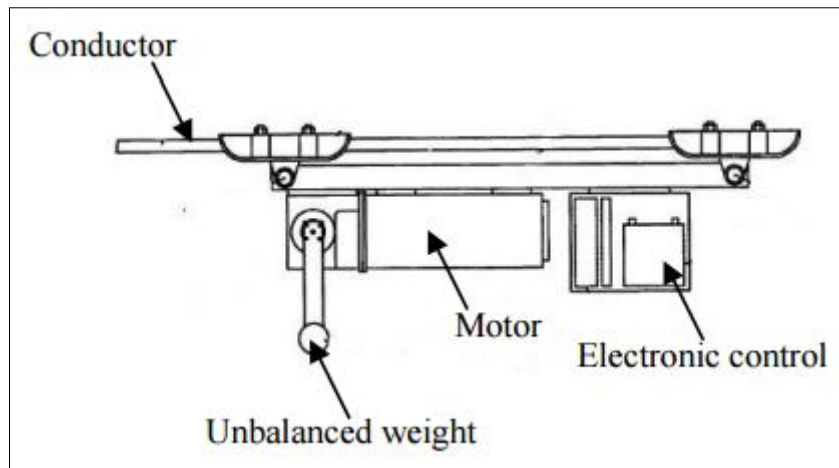

Figure 45: Ice shedder after Volat.C, Farzaneh.M 2005 [35]

6.2.3 Thermal Methods

Thermal method involves heating of transmission line, which melts the ice buildup and its widely used for deicing operations and considered most reliable method. It can also be used for anti-icing and de-icing and both AC and DC current used for thermal method. De-icing duration can be analyzed as a function of air temperature, ice thickness, wind speed and cable thickness. However AC current method is cheapest as it only requires to construct ice melting bus-bars with a circuit in the substation from where ice melting operation can be carried out [47][48].

Thermal method de-icing can be subdivided in to two parts:

1. Methods based on pure joule effect.
2. Methods based on dielectric losses, radioactive waves and external heat sources.

6.3 METHODS BASED ON JOULE EFFECT

Electrical energy lost due to resistance to high current flowing via conductor (Joule effect) is due to changes to a thermal energy that melts ice buildup on conductors. Such method is the oldest method that has been successfully used since 1920s De-icing and anti-icing using Joule Effect Method, have been implemented and used by many companies around the world. However, length of conductor also plays a part in such operations. Ice melting process can be done either by alternative current or by direct current. However, mostly transmission line transports alternative current from source generation to consumers. Another advantage is that it's cheaper to utilize the AC within the transmission line. However, during extreme

atmospheric conditions and longer transmission lines, the heating power could be higher than the line capacity. In this case we may consider different de-icing methods [35] [36][49].

6.3.1 Joule-Effect Thermal and Electricity Analysis Model

Joule-effect heating for de-icing was used first time in 1920 and used widely in USA Russia and Canada. However, as transmission lines became longer using joules-effect method became bit challenging. The main purpose of this method is to keep surface temperature above 0°C and can be regulated by nominal current in transmission line. This current depends on various factors such as: ambient air temperature, conductor diameter, ice thickness in cases of de-icing-using such parameters. It is possible to analyze the current required to prevent ice/snow accretion on the transmission line. By considering convectional heat loss, an equation is derived to calculate temperature increment on transmission line surface area above ambient air temperature for wind speeds greater than 1m/s in order to prevent ice accretion. The equation is given as:

$$\Delta T = 4.43 \times 10^{-4} \frac{I^2 R_{AC}}{\sqrt{dv}} \quad (6.1)$$

Where: ΔT is the temperature rise (in °C)

R_{AC} is the conductor AC resistance (in Ω/km)

I is the conductor current (in A)

d is the conductor diameter (in mm)

v is the wind speed (in m/s)

The de-icing current can be analyzed by the equation (6.2)

$$I = 1.7725 \sqrt{\frac{(w_i + w_c)d}{R_{AC}}} \quad (6.2)$$

Where: R_{AC} the conductor AC resistance (in Ω/km)

w_i is the melt-through power (in W/m²)

w_c is the power required to maintain temperature rise (in W/mm²)

d is the conductor diameter (in mm)

The equations, (6.1) and (6.2) can be taken as basic equations that do not take consideration of heat lose and gain due to radiation. Therefore, the equations supposed to include the

radiation values in order to improve the de-icing efficiency. Researchers in Canada have developed the above equations and the equation (6.3) by accumulating several years de-icing data focusing heat losses due to radiation and heat gain due to solar energy. Equation (6.3) can evaluate the amount of current that can melt a certain amount of ice within a certain time Δt .

$$I = \sqrt{\frac{1}{R_{AC}} \left(P_C + P_S - P_{SOL} + \frac{\rho_i (L_F + C_{pI} (T_F - T_A))}{\Delta t} \right)} V_{MELT} \quad (6.3)$$

Where: R_{AC} is the conductor AC resistance (in Ω/km)

P_C is the convective heat transfer (in W)

P_S is the radiative heat transfer (in W)

P_{SOL} is the solar heat transfer (in W)

ρ_i is the ice density (in kg/m^3)

L_F is the latent heat of fusion (in J/kg)

C_{pI} is the specific heat of ice (in $\text{J}/\text{kg}/^\circ\text{C}$)

T_F is the fusion temperature of ice (in $^\circ\text{C}$)

T_A is the ambient temperature (in $^\circ\text{C}$)

Δt is the required time for a melt (in s)

V_{MELT} is the volume of ice sector to be melted above the conductor (m^3)

Equation (6.3) has a limit to be used in dry ice-grown condition, that means the formula is derived in a way that all precipitation contacts is assumed to be captured and frozen on the iced line. And heat transfer related to precipitation contact is ignored. So, the analysis using this formula may not be effective in mild temperatures, when the ice accreted on a wet regime and drips down the ice surface. This may contribute to de-icing process or remove extra heat energy from the iced transmission line. To avoid wet-grown ice related heat transfer limitations, Hydro-Quebec has developed new ice melting model. In addition to that, the new model has been improved by consideration of captured water and ice elements. The model has been formulated but has not been validated yet.

The general formula is given by Equation (6.4).

$$I = \sqrt{\frac{r_c}{r_l} \left(\frac{\rho_I (L_F + C_{pI} (T_I - T_A))}{R_{AC} \Delta t} \right)} V_{MELT} \quad (6.4)$$

where: R_{AC} is the conductor AC resistance (in Ω/km)

L_F is the latent heat of fusion (in J/kg)

ρ_I is the ice density in kg/m^3)

r_c is the radius of the conductor (in m)

r_l is the outer radius of the ice sleeve (in m)

C_{pI} is the specific heat of ice (in J/kg/°C)

T_I is the temperature of the ice (in °C)

T_A is the ambient temperature (in °C)

Δt is the required time for a melt (in s)

V_{MELT} is the volume of ice sector to be melted above the conductor (m^3)

Some values of de-icing current as a function of conductor type and environmental conditions is shown on Table 6 [35][36][50][51][52][53].

Conductor	Diameter (mm)	Ice thickness (mm)	Wind velocity (km/h)	Ambient temperature (°C)	Current (A rms)
Bersimis 1360 MCM ACSR	35	10, 20, 50	10, 30	-1, -5	1320, 1850
Condor 795 MCM ACSR	28	10, 20	10, 30	-1, -5, -10	970, 1350
GW ½ in.	13	10, 20, 50	10, 30	-1, -5	120, 170
Bersfort 1354 MCM ACSR	36	20	60	-2, -5	1900
OPGW	23	20	30, 60	-2, -5	920
GW 7/16 in.	11	20	60	-2, -5	170
OPGW	17	20	30, 60	-2, -5	600

Table 6: De-icing current values that is required for different types of conductors [50]

In Canada researchers had conducted different experiment, focusing ice accumulation during winter season, and application of joules effects for deicing the transmission lines.

Some of the deicing methods are:

- Direct current joules effect.
- Load transfer joules effect.
- Reduced or full voltage joules effects.
- High magnitude short circuit.
- Contractor load transfer.

It was concluded that Joule effect de-icing techniques combined with tower reinforcement, displayed the most cost-effective solutions to limit mechanical loads on transmission lines subjected to severe ice storms. Along with that the load transfer method, being the cheapest way to melt ice on conductors that can be applied to about 120 transmission lines rated from 49 to 315 kV. The reduced or full voltage short-circuit method will also be used on many lines over 50kV where voltage and power available at the source substation are appropriate for the line length configuration. Table 7 below gives comprehensive outcome of different de-icing methods [54].

DISCRPTION	APPLICATION	CRITERIA/WEIGHT									
		R&D cost 5%	R&D risk 14%	Implementation cost 16%	Maintenance cost 9%	Operating cost 10%	Realization time 12%	Reliability 15%	Complexity 10%	Impact on customers 9%	TOTAL/ 5
LOAD TRANSFER (joule effect)	49 to 315kv lines	5	5	5	5	4	5	3	4	3	4.32
Direct current (joule effect)	Bundle conductor lines	5	5	2	4	4	3	4	4	4.5	3.80
Reduced or full voltage short-circuit (joule effect)	49 to 315kv lines	5	5	3.5	4	3	3	4	3	4	3.79
High magnitude short circuit -(magnetic forces)	Bundle conductor lines	3	3	4	5	4	4	3	3	3	3.56
Mechanical reinforcement	Any line	5	5	0	3	5	2	4	5	5	3.51
Contactore Load transfer (joules effect)	Bundle conductor lines	0	2.5	3.5	2.5	4.5	0	3	4.5	3	2.76

Table 7: Different joules effects by Pascal Prud Homme et al 2005 [54]

6.3.2 Direct Current Joules Affect Method

In this method, DC current used for de-icing of 735KV lines, since the line having 4 conductors and covers a distance of average length is 250km. For longer transmission lines, DC source can provide sufficiently high ice-melting power. For DC current source they used 285MVA transformer with converter to operate as a static var compensator under normal operating conditions. However, in Table 7, the R&D cost is highest and its reliability is just 4% out of 15% but overall this method is second best. If we take overall criteria, Russia has been successfully developed and installed this technology to melt ice on a large bundled transmission lines with a capacity of 500kv. Also, 220kV or 110kV transmission lines need less than 25 Mvar power source while deicing, with that we use mobile dc power supply deicer. It gets power via removable generators and the de-icing capacity is determined by the capacity of generator. This can be used for the transmission lines under 35kv. It is not cost effective for 500kV AC transmission line or above. The method using DC current for deicing is quite simple and we see the Figure: 46 below:

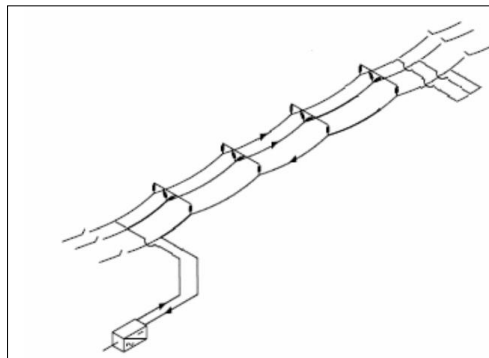

Figure 46: DC methods for deicing of 735KV line by [11]

We can see in Figure 46 above, that demonstrates a rectifier circuit and its designed to melt the ice on transmission lines, since it's considered that 7200A current would be enough to melt 12mm of ice in half hour at -10°C [11][54][59].

6.3.3 Load Transfer Joule Effect Method

Joules effect is a method in which heat is generated by electrical current. Since this method requires additional current to de-ice existing power line. It is considered more suitable to be preferred for single conductor line. This method does not require extra equipment on the transmission line and deicing can be achieved by increasing load current in the system in order to melt ice from the line. The general concept is just increasing current in the system by transferring or shifting loads from other circuits connected to the same two substations and if

we have two circuits or bundle conductors, then at least two substations required to carry out de-icing operation. Another drawback of this method is controlling the flow of current, since it's observed that overheating can shorten the conductor life. Circuit overloading raises the amount of current circulating in the system and this overloading current can increase the conductor temperature that induces ice melting. This method can be complex on long bundle transmission lines as it requires huge current and is not easy to control the current flow during de-icing period [11].

6.3.4 Reduced or Full Voltage Joules Effects Method

In this method it's required to apply a three-phase short-circuit on one end of the circuit and a three-phase voltage source on the other end of the circuit. Extra high current is generated to de-ice the line. It is obvious that if any electric power equipment short-circuited, then the result will be heat energy. Heat energy due to short-circuited electrical energy depends on the resistance on the conductor. However, in this method, reduce voltage is enough to generate the desired current to de-ice the conductor and can be applied on line up to 230KV. For lines above 230KV require high voltage. Reason is number of conductors increases as the transmission line capacity - KV increases [54][55].

6.3.5 High Magnitude Short Circuit Method

In this method very high current applied to make all conductors in a bundle to knock against each other. That results in the ice to fall down. This knocking effect is generated by applying of a very large current of the same type as a short-circuit current. Since the method requires two consecutive short circuit applications of 10KA. Short-circuit time is less than half a second and the time between applications is about 1 second in order to generate heat and apply the knocking force. Since the amount of required current is high, this can only be used to short lines and also has a drawback of high voltage drop resulting in unstable network [11].

6.3.6 Contractor Load Transfer Method

This method is useful to de-ice bundle conductors. The process is repeated for each conductor in the bundle till the de-icing is completed. In this method, a contactor device installed in the bundle spacers controls the current flow in the bundle and allows current to flows to one conductor at time. The process is repeated till all conductors de-iced [54][11].

6.3.7 Methods Based on Dielectric Losses, Radiative Waves and External Heat Sources

In 33kv 100kHz, we find very high frequency electric field that can be utilized to melt ice via dielectric losses. Di-electric losses, radiative waves and external heat source are different than joule effect method. Thermal effect generated from high frequency that causes a direct heat in the ice. Heat due to skin effect is produced as a result of resistive losses on the conductor surface. Theoretically, this method has been demonstrated in the laboratory on 1m transmission line with 30kv source and found effective against 7mm ice layer. The second method used as external heat source is by using steam based heating technique. Quebec municipalities frequently use this technology for de-energizing of electrical equipment like switches and post insulators. An industrial proto type of the de-icer includes a remote controlled, isolated telescopic mast of 16 m in length and isolated steam hose on the outside of the mast that can be used to de-ice equipment rated 145 to 330 kV. The equipment can be used to de-ice a specific location of transmission line during critical failure. Below we can see in Figure 47 using steam for deicing [56][57].



Figure 47: Steam cleaning of insulators [57]

6.3.8 Ultrasonic De-Icing for High Voltage Transmission Line

In this method, it's noticed that adhesive bond of ice-substrate interface is quite weak in shear and therefore piezoelectric actuators can be used to generate local shears at the spots of ice accretion to weaken the ice buildup by making use of normal impulse force of ultra-sonic transducers. Torsional stress is generated by curved PZT patch on the surface of the aluminum pole that exceeds the ice shear adhesion strength that results in crack ice patch and fall off due to gravity. It's very important, how to fix it on pole and changes in design made it

possible to connect it to transmission line and de-icing was achieved successfully. Below we can see the improve design in Figure: 48 that are in practical use in china [58].

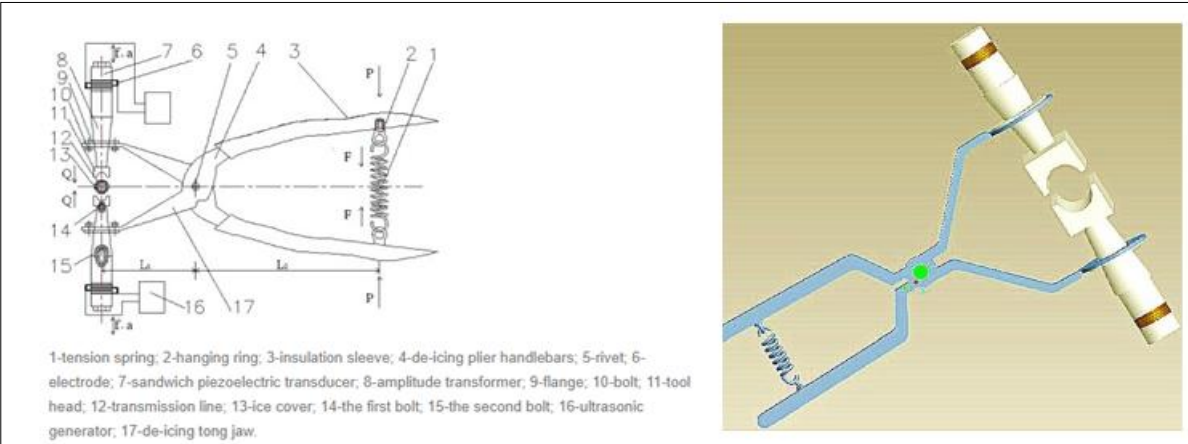

Figure 48: Ultrasonic de-icing device with one clamp [58]

6.3.9 Reactive Current De-icing

In this method a shunt capacitor at the power supply and adjustable reactor at load side is installed and reactivated current is injected into the transmission lines that create heat to melt the ice. The installation of shunt compensation capacitor and parallel adjustable inductor are convenient with less amount of workload. This method requires additional equipment when deicing operations are required. If we have loop network, it is difficult to make a feasible control of reactive power flow. This method is rarely used in the power system because adjusting the reactive power flow may cause the unsteady problem of the network [59].

6.3.10 Phase-Shifting Transformer De-icing

The advantage of this method is that we can achieve deicing without taking out line out of service. Phase shift transformer can generate an active power circle. First line transmits forward and the second line transmits backward. The increased forward transmission current and its value are equal to the phase-shifting current. In addition with load current that causes circulating current to flow over a transmission line to de-ice. Running current depends on the line impedance and the degree of phase shift. Under the normal operating conditions, this method has the icing conductor, which can melt ice by adjusting the circulating current of the double circuit transmission lines [59].

CHAPTER 7

DISCUSSION

7.1 ICING BRINGS FINANCIAL LOSES

The biggest adverse effect of icing is that, it reduces the life of the infrastructure. Additional ice load and low temperature put stress on the network. It's necessary to have a dedicated manpower that is responsible to inspect the line year-round and perform required inspection and maintenance. So, during winter period the network is robust enough to withstand adverse weather conditions. Latest technological advancements come up with hybrid material that can withstand low temperature and resist ice buildup. Previous power outage events clearly showed that maintenance operations cost goes up to millions. And that is just the repair cost of power outage. The other cost includes interruption of other utilities that runs from electrical power such as: heating, telecom, hospital, schools etc. Power outage affects almost every aspect of daily life in terms of financial, physical and emotional side. It is highly recommended that icing and cold weather should be considered in design phase. So that the towers can adjust with the additional load, also insulator should be good enough to resist ice buildup and require minimum maintenance.

7.2 EFFECTS OF ICE ON POWER INFRASTRUCTURE CROSSING DIFFERENT TERRAINS

Different types of ice precipitate under different temperatures, and wind speed and wind direction also plays an important role in ice formation. Wind direction is responsible for ice adhesion and it's more effective when it blows perpendicular to line. Also, height of the tower and its location plays an important part. Suppose if the line is crossing mountainous region then icing phenomenon is most extreme and damage the infrastructure swiftly and if the line passes close to coastal area, then we may have saline ice particles in the snow that can contaminate insulator and conductor. Fault restoration work is most difficult if any breakage of line or insulator happen on mountainous region. And it's a challenging task to repair fault on hilly region.

7.3 COMPARISON BETWEEN DIFFERENT ICE FORMATION MODELS

This work discussed several ice models that were used for ice calculation. And it was noted that none of the models are perfect, but good enough to give good ice calculation readings. Also we see that setting up parameters is important factor since it gives reliable reading.

There are different parameters for in-cloud icing and precipitation icing. And not all the models can be used for ice buildup calculation on power lines. Table 2, presented in chapter three shows advantages and shortcomings among several ice models.

7.4 EFFECT OF ICE AND SNOW ON POWER LINES

Transmission lines go under several stresses that include wake-induced oscillations and aeolian vibrations. Aeolian vibrations under icy conditions may result in fatigue problem. Spacers are useful against wake-induced oscillations. Galloping is another factor, that is caused by the wind and occurs in ice accreted single and bundle conductors. Galloping in transmission line can be seen as excitation on the span in which icing is present, that causes an aerodynamically unstable movement when the cable oscillates. Since such problems can easily cause phase to phase and phase to ground faults. Therefore, it is useful to add spacers that reduce unnecessary motion in the conductor. Also, additional ice load on line may create load stress on towers and conductors and with time weaken the foundation of towers. So, its high recommended that while designing a network, ice loads should also been included.

7.5 COMPARISON BETWEEN ICE MONITORING SYSTEM USING DIFFERENT SENSORS

Sensors are useful device to detect icing on power line. Sensors are small in size and can be easily installed on power lines. It is mentioned in ISO 1249 for calculation of icing load, that a slowly rotating steel rod that is at least 0.5-meter long (or 1 meter if heavy icing is observed), and has the diameter of 30 mm is used for ice load measurements. During this research work several sensors have been discussed, which are used to calculate ice loads during different icing events. Such information is useful when there occurs heavy icing event, and that reading can be used for maintenance operations. Sometimes sensors cannot distinguish between different type of icing and gives false reading. Also, extreme low temperature can reduce the life of sensors. But sensors are practically used on monitoring power line and are useful in ice calculations. Table 4 presented in chapter five gives pros and cons between several ice sensors.

7.6 DE-ICING AND ANTI-ICING OF POWER LINE

Both de-icing and anti-icing are vital operation for transmission line and are useful to ensure continuous power supply. There are numbers of ways to de-ice/ anti-ice the circuits. This study explains that new materials that are used to reduce the ice buildups for example: Poly-

tetrafluoroethylene and Poly dimethyl siloxane and also the snow ring are few of the several methods that are used against ice buildup.

Poly-tetrafluoroethylene and Poly dimethyl siloxane and the snow ring lie under passive anti-icing method. Also by making changes in design of line, ice buildup can also be reduced. In active de-icing method, physical force is required such as vibration, shock waves, scraping and additionally we can also use current method, like Joule-effect heating, that is considered to be most effective. Several other methods can also be used with that for example, direct current joules effect method, load transfer joule effect method, reduced or full voltage joules effects method for de-icing. Table 7 presented in chapter six shows pros and cons between different joule effect methods.

CHAPTER 8

CONCLUSION

Transmission line is a critical component in power supply system. Therefore, it is very important to keep it functional and to prevent it from any potential damage. Accreted ice/snow causes the external load and stress on transmission line, so the line has to be constructed in such a manner that external load on the line do not pass beyond the lines tensile strength. Continuous reliable information about the status of the network and continuous surveillance of the transmission line could be the best approach for a tripping free distribution and transmission network. It is recommended to install either fixed or mobile sensors in detecting the amount of ice/snow on the line. The installation work for existing power network could be challenging, but can be useful to detect the snow load in real time. Mobile aerial surveillance technology like drones or helicopters can be useful, because it is fast, affordable and does not require any contact to the existing power line, but a clear weather and low winds are prerequisite to carry out such operations. UAV (unmanned aerial vehicle) or drone is the most cost-effective inspection task compared to helicopter. UAV equipped with a laser scanner, cameras and aviation safety systems has the capability for long distance inspection.

These inspection techniques are supposed to give the important information related to the maintenance operations required for power lines. Maintenance task could be anti-icing or de-icing operation. There are number of methods to remove ice/wet snow from transmission lines. These methods are different depending upon mechanism used, accessibility, effectiveness, cost and covering distance. The recent research on ice-material adhesive used for anti-icing coating mechanisms, suggests improved coating material for the transmission line that is useful against ice buildup. Manipulation of atomic and molecular arrangement of a material could be possible to develop non-ice adhesive coatings. This technology is known as nanotechnology. Low or non-adhesive coating can shed snow/ice from the transmission line by its own weight. This anti-icing method is passive de-icing, that means it does not require external source to de-ice the circuit. De-icing operation using mechanical method can be useful for the protection of shorter sections of transmission line. Some of the mechanical de-icing methods can be carried out by human involvement, by making use of ropes and roller wheels. If the line crosses difficult landscape then the de-icing process is more demanding and in case of wet conditions it could expose human life to electrical shock. Mechanical

method may damage the conductor due to unbalance weight distribution in de-icing operations.

Robotic inspection for de-icing may solve most of the mechanical de-icing uncertainty, but there is still a long way to reach a fully developed de-icing solution, since it is time consuming and low speed operation and is only available for inspection purpose. Thermal de-icing is the best method to melt ice/snow for long distance overhead transmission lines. Especially joule effect method has been used for de-icing operations, and gives the desired results. The study of fault rates for last fifty years shows that the technology has evolved enough to face the harsh weather conditions and power outage events have reduced constantly. However, climate change may bring extreme low temperatures and uneven pattern of snow. To handle this new developing scenario related to climate change a continuous research and development studies can be a way forward.

REFERENCES:

- [1] Hyde M. M., James W. F. “Transmission Icing a Physical Risk with A Physical Hedge” Power Engineering Society General Meeting, IEEE Print ISBN: 1-4244-0493-2, 2006.
- [2] https://www.hydro.mb.ca/outages/ice_on_power_lines.shtml Accessed on March 2017.
- [3] Masoud F. “Atmospheric Icing of Power Networks” e-ISBN: 978-1-4020-8531-4_ Springer Science+Business Media B.V. 2008.
- [4] Harold M. I, et al. “Wind Ice and Snow Load Impacts on Infrastructure and the Natural Environment” Proceedings - Int. Workshop Atmos. Icing Struct. Uppsala, 2015.
- [5] <http://www.inmr.com/impact-icing-transmission-lines/> accessed on March 2017.
- [6] Masoud F., et al. “Coatings for Protecting Overhead Power Network Equipment in Winter Conditions” ISBN: 978-2-85873-334-7 CIGRE Publication 2015.
- [7] Abbas.B., et.al “Designing for Performability : An Icing Risk Index for Arctic Offshore” Cold Regions Science and Technology. Volume 124, Pages 77-86 April 2016.
- [8] Heyun L., Xiaosong.G.,Wenbin.T. “Icing and Anti-Icing of Railway Contact wires” Changsha University of Science and Technology, Hunan Province China march 2012.
- [9] Wiebe E., Friedrich.L. “Facing the Winter Challenges for Railways in Europe Winter & Railways” Fact Sheet Snow and Ice, Paris October, 2010.
- [10] Broström E. “Ice Storm Modelling in Transmission System Reliability Calculations” Licentiate Thesis KTH Sweden 2007.
- [11] CIGRE publication Working group B2.29. “Systems for Prediction and Monitoring of Ice Shedding, Anti-Icing and De-Icing for Power Line Conductors and Ground Wires” December 2010.
- [12] Matteo L., et al. “Wet-Snow Activity Research in Italy” Proceedings - Int. Workshop Atmos. Icing Struct. Uppsala, 2015.
- [13] Karoliina H., Sami N. “Verification of Icing-model, in Finland” Finnish meteorological Institute, Helsinki, Proceedings - Int. Workshop Atmos. Icing Struct. Uppsala, 2015.
- [14] Xiang J. Z., et al. “A Novel Thickness Detection Method of Ice Covering on Overhead Transmission Line” 2nd International Conference on Advances in Energy Engineering (ICAEE 2011) © Published by Elsevier Ltd, 2011.
- [15] Heli K., et.al.“Research on Icing Behavior and Ice Adhesion Testing of Icephobic Surfaces” Proceedings - Int. Workshop Atmos. Icing Struct. Uppsala, 2015.
- [16] Antti M., et al. “Recognizing Climate Change in Electricity Network Design and Construction” ISBN 978-951-38-6977-9 VTT Technical Research Centre of Finland, 2007.

- [17] <http://www.statnett.no/en/> viewed on march 2017.
- [18] Thomas K. S. “Composite Based EHV AC Overhead Transmission Lines” Phd thesis Technical University of Denmark 2010.
- [19] Pierre V. D., David G. H. “Effect of Ice and Snow on the Dynamics of Transmission Line Cables Part I: Aeolian Vibration, Wake-Induced Oscillation and Galloping Motions” IWAIS XI, Montréal, June 2005.
- [20] Jaroslav Š., et al. “Automated Icing Monitoring System on the Territory of the Czech and Slovak Republic” Proceedings - Int. Workshop Atmos. Icing Struct, Uppsala. 2015.
- [21] Xin B. H., et.al “The Recognition and Detection Technology of Ice covered Insulators under Complex Environment” Proceedings - Int. Workshop Atmos. Icing Struct, Uppsala 2015.
- [22] Minullin R.G.,et.al. “Technology Radar Monitoring of Overhead Power Lines When Detecting Ice Formations” Proceedings - Int. Workshop Atmos.Icing Struct, Uppsala 2015.
- [23] Wadham.M.G., et.al. “Ice Detection Methods and Measurement of Atmospheric Icing” Proceedings - Int.Workshop Atmos. Icing Struct, Uppsala 2015.
- [24] Sergey C.,et.al.“Fault Statistics on Overhead Transmission Lines in Russia Caused By Icing ” Proceedings - Int. Workshop Atmos. Icing Struct, Uppsala 2015.
- [25] Lasse M. “Modeling Power Line Icing in Freezing Precipitation” Atmospheric Research Volume 46, Issues 1–2, FINLAND 1998.
- [26] Kathleen F. J. “A Simple Model for Freezing Rain Ice Loads” Atmospheric Research Volume 46, Issues 1–2, Pages 87–97, NH 03755-1290, USA 1998.
- [27] Phillips T.N., et.al. “T x Dot and Electric Power Transmission Lines” Texas tech University – multidisciplinary research in transportation, University of Texas 2010.
- [28] Major.J., et.al. “Future Inspection of Overhead Transmission Lines” Electric Power Research Institute Palo Alto, CA 2008.
- [29] IEEE Power Engineering Society. “IEEE Standard for Calculating the Current Temperature Relationship of Bare Overhead Conductors” institute of electrical and electronics engineers, New York, NY, USA 2013.
- [30] Expliner - Robot for Power Line Inspection <http://www.hibot.co.jp> Accessed on June 2017.

- [31] Debenest.P., Guarnieri. M. “Expliner-From Prototype Towards a Practical Robot for Inspection of High-Voltage Lines ” first international conference on applied robots for the power industry, Montreal Canada 2010.
- [32] Pagnano.A.,Höpf.M., Teti.R. “A Roadmap for Automated Power Line Inspection Maintenance and Repair” 8th conference on intelligent computation in manufacturing engineering 2013.
- [33] Debenest.P.,et.al. “Expliner Toward a Practical Robot for Inspection of High-Voltage Lines” Volume 62 of the series Springer Tracts in Advanced Robotics pp 45-55 2010.
- [34] T&D world magazine. “Drones for Power Line Inspections” January 2017.
- [35] Volat.C., Farzaneh.M. “De-icing/Anti-icing Techniques for Power Lines Current Methods and Future Direction” Industrial Chair on Atmospheric Icing of Power Network Equipment (CIGELE) and Canada Research Chair on Engineering of Power Network Atmospheric icing June 2005.
- [36] CIGRE publication Working group B2.29. “Systems for Prediction and Monitoring of Ice Shedding, Anti-Icing and De-Icing for Power Line Conductors and Ground Wires” December 2010.
- [37] Boluk. Y., “Adhesion of freezing precipitates to aircraft surfaces” Report Transportation Development Centre on behalf of Civil Aviation Safety and Security Transport Canada No. TP 12860E, Optima Specialty Chemicals and Technology Inc, 1996.
- [38] Croutch. VK.,Hartley. RA. “Adhesion of Ice to Coatings and the Performance of Ice Release Coatings” Journal of coating s technology, Federation of Societies for Coatings Technology 1999.
- [39] Nakagami. M. “Verification nn Effects of PTFE Tapes on Reducing Snow Accretion on Overhead Power Transmission Lines” In: proc 12th International workshop on atmospheric icing of structures, Yokohama 2007.
- [40] Murase. H., et.al. “Interactions between Heterogonous Surfaces of Polymers and Water” Journal of applied polymer science 1994.
- [41] Hiroki M., Kazuhide. O. “Effect of Snow Accretion Resistance Measures on Overhead Transmission Lines” Tohoku Electric Power Co., Inc. 2007.
- [42] Sakamoto.Y. “Snow Accretion on Overhead Wires” Philosophical Transactions of The Royal Society, Mathematical, Physical and Engineering Sciences, Research Frontiers 2000.
- [43] Barry.O., et.al. “Nonlinear Dynamics of Stockbridge Dampers” Journal of Dynamic Systems, Measurement, and Control Vol. 137 / 061017-1 2015.

- [44] Leblond.A., et.al. “New Results on The Anti-Icing Performance of LC-Spiral Rods” The 14th international workshop on atmospheric icing of structures, Chongqing, China May 2011.
- [45] Leblond.A., et.al. “Performance Study of LC-Spiral Rods under Icing Conditions” September 2009.
- [46] Leblond.A. ,et.al. “Development of a Portable De-Icing Device for Overhead Ground Wires” Rapport HQ-94-01, Hydro-Québec, June 2005.
- [47] Shakirov.R.G., et.al. “Organization of the Melting of Ice by an Alternating Current on the Wires of Overhead Electric Power Lines” Translated from *Élektricheskie Stantsii*, No. 2, pp. 58 – 62 February 2012.
- [48] Motlis.Y. "Melting Ice on Overhead-Line Conductors by Electrical Current" CIGRE SC22/WG12 document, draft no. 4, revised for the WG12 Meeting, Paris, 2002.
- [49] Oliver C.R., “Sleet and Ice Troubles on Transmission Lines in New England”, AIEE Paper, May 1925.
- [50] Pascal. P.H.,et.al. “Determination of Current Required to De-Ice Transmission Line Conductors” Montréal, June 2005.
- [51] Huneault M., Langheit C. and Caron J., “Combined Models for Glaze Ice Accretion and De-Icing of Current-Carrying Electrical Conductors” IEEE Trans, April 2005.
- [52] Clem J.E. “Currents Required to Remove Conductor Sleet”, December 1930.
- [53] Farias A.R. “De-Icing Technologies – Introduction to Manitoba Hydro’s Use of NIce Melting and NIce Rolling Technologies to Remove Ice from Sub transmission and 115 KV Transmission Lines”, CEA Electricity 99, Vancouver, 1999.
- [54] Pascal. P.H., et.al. “Hydro-Québec TransÉnergie Line Conductor De-Icing Techniques” IWAIS XI, Montréal, June 2005.
- [55] W. D. Adolphe, "Ice Melting of sub-Transmission Lines" Manitoba Hydro, CEA paper, Toronto, Nov. 1992.
- [56] Joshua D.M., et.al. “Using Dielectric Losses to De-Ice Power Transmission Lines with 100 kHz High Voltage Excitation” Thayer School of Engineering Dartmouth College Hanover NH 03755 2001.
- [57] Lanoie. R., Bouchard. D., Lessard M. “Using Steam to De-Ice Energized Substation Disconnect Switch” IWAIS 2005 Montréal, Canada, June 2005.
- [58] Zhenjun. W. “Recent Progress on Ultrasonic De-Icing Technique Used For Wind Power Generation, High-Voltage Transmission Line and Aircraft” at Elsevier B.V. Energy and Buildings 140 china 2017.

- [59] Deepika. S.,et.al. “A Review Paper on Icing and Methods to De-Ice the Transmission Line” International Journal of Engineering Research and Reviews Vol. 3, Issue 2, India 2015.
- [60] Umair N., Muhammad S., Mohamad Y. “State of the Art Review of Atmospheric Icing Sensors” Institute of Industrial Technology, UiT Arctic University of Norway, Norway March 2016.