

# **QRA Techniques on Dynamic Positioning Systems During Drilling Operations in the Arctic:**

*With Emphasis on the Dynamic Positioning Operator*

—  
**Runar Nikolai Pedersen**

*Master's thesis in EOM-3901 Energy, Climate and Environment*

June 2015

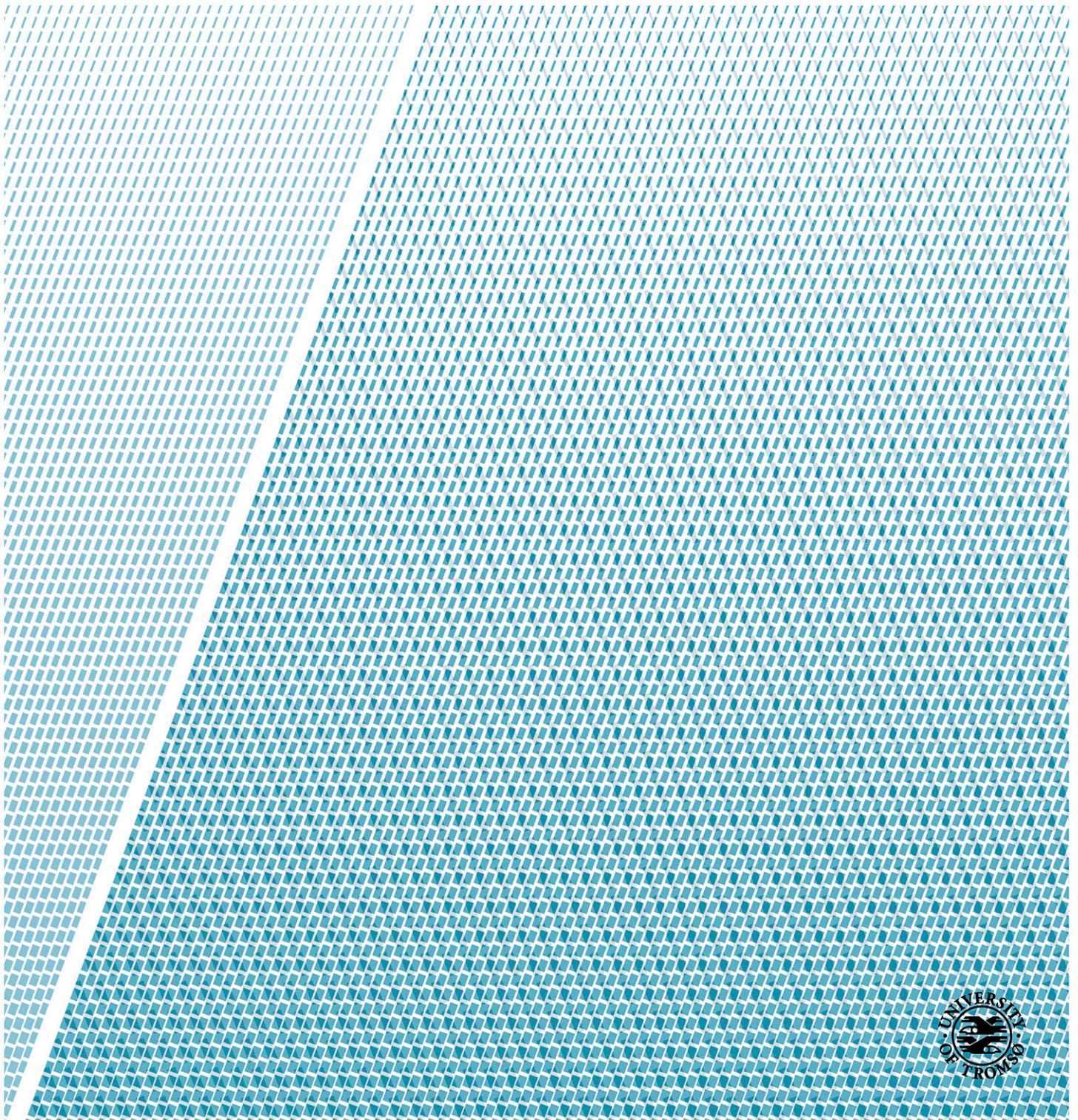





## Abstract

With the Norwegian government moving the ice edge farther north than ever before, opening for new areas for petroleum exploration, it will need research on how these areas can affect oil and gas operations. A sensitive environment along with the harsh Arctic climate and remote distances means that severe accidents, like blowouts, will have serious impacts and make cleanup and rescue actions to challenging operations. Additionally, humans working under these conditions are prone to be affected with regards to their reliability, which means that human errors are more likely to occur.

The use of dynamic positioning systems as position-keeping solutions on mobile offshore drilling units is becoming increasingly popular as it is quick and easy to change position, independent on seabed conditions and does not need handling of anchors. The dynamic positioning operation is managed by an operator who is responsible for keeping the vessel in position, in addition to being a barrier for safely shutting in the well and disconnecting the riser configuration from the BOP when position-keeping is not possible.

Quantitative risk assessment techniques have been used in the offshore industry for decades. They are usually applied to operations and technical systems, but are also possible to utilize for analyzing humans and their contribution in a risk picture.

Based on a set of precautions, a model for analyzing dynamic positioning systems during loss-of-position events in the Arctic, with the focus particularly on the dynamic positioning operator, is in this thesis developed. A fictional comparison between a dynamic positioning drilling operation influenced by Arctic conditions and a similar operation in an area not exposed to such conditions is also provided. The comparison will indicate to which extent the reliability of the dynamic positioning operator is decreased by influence of Arctic conditions, and the role this plays in the recovery phase of loss-of-position events. Hopefully the findings in this thesis can contribute to safer oil and gas operations in the Arctic.



# Acknowledgments

This thesis is the final part of the requirements for the degree Master of Science at the University of Tromsø in the study program Energy, Climate and Environment within the specialization Technology and Safety in the High North.

First of all, I wish to thank my supervisor Associate Professor Abbas Barabadi for helping me defining the thesis and providing guidance, solutions and materials whenever asked for.

I would also like to express my gratitude to DNV GL's offices in Harstad and Tromsø for giving me the possibility to write this thesis with their guidance, and for providing me with resources and having valuable meetings. It has without doubt been a substantial advantage to be provided with their experience and hospitality

I would also like to thank my friends and study colleagues in Tromsø and elsewhere. I will especially highlight The Office for providing the most inspiring environment throughout these five years. It has been a real pleasure to share valuable academic discussions with you, especially in the thesis period, in addition to cups of coffee and not to mention the laughs.

Appreciation should also be pointed to Professor Javad Barabady for his kindness and providing the possibility to write the thesis and enroll in courses in the study program Technology and Safety in the High North.

Finally, my sincerest gratitude goes to my family who has been supporting me throughout the study period. A special thank goes to my sister for proofreading my thesis.

*Runar Nikolai Pedersen,  
June 2015*



# Abbreviations

<b>ALARP</b>	As Low As Reasonably Practicable
<b>BOP</b>	Blowout Preventer
<b>BSEE</b>	Bureau of Safety and Environmental Enforcement
<b>DARPS</b>	Differential Absolute and Relative Positioning Sensor
<b>DGNSS</b>	Differential Global Navigation Satellite System
<b>DGPS</b>	Differential Global Positioning System
<b>DNV</b>	Det Norske Veritas
<b>DNV GL</b>	Det Norske Veritas Germanischer Lloyd
<b>DP</b>	Dynamic Positioning
<b>DPO</b>	Dynamic Positioning Operator
<b>EQD</b>	Emergency Quick Disconnect
<b>ERN</b>	Environmental Regularity Number
<b>ETA</b>	Event Tree Analysis
<b>FPSO</b>	Floating Production, Storage and Offloading
<b>FTA</b>	Fault Tree Analysis
<b>GNSS</b>	Global Navigation Satellite System
<b>HDOP</b>	Horizontal Dilution of Precision
<b>IMCA</b>	International Marine Contractors Association
<b>IMO</b>	International Maritime Organization
<b>LBL</b>	Long Baseline
<b>LMRP</b>	Lower Marine Riser Package
<b>LOP</b>	Loss Of Position
<b>MODU</b>	Mobile Offshore Drilling Unit
<b>MTS</b>	Marine Technology Society
<b>NCS</b>	Norwegian Continental Shelf
<b>NOFO</b>	Norsk Oljevernforening For Operatørselskap
<b>NPD</b>	Norwegian Petroleum Directorate
<b>OSV</b>	Offshore Supply Vessel
<b>PSA</b>	Petroleum Safety Authority Norway
<b>QRA</b>	Quantitative Risk Assessment
<b>RBD</b>	Reliability Block Diagram
<b>ROV</b>	Remotely Operated Underwater Vehicle
<b>SDS</b>	Safe Disconnect System





# Contents

<b>Abstract</b>	<b>iii</b>
<b>Acknowledgments</b>	<b>v</b>
<b>Abbreviations</b>	<b>vii</b>
<b>List of Figures</b>	<b>xiii</b>
<b>List of Tables</b>	<b>xv</b>
<b>1 Project Outline</b>	<b>1</b>
1.1 Output for Reader and Background for Study . . . . .	1
1.2 Scope and Limitation of the Study . . . . .	3
1.2.1 Scope . . . . .	3
1.2.2 Limitation of study . . . . .	5
1.3 Organization of Thesis . . . . .	7
1.4 Data Collection and Relevant Databases . . . . .	7
1.5 Previous Work on the Subject . . . . .	8
1.5.1 QRA and HRA in the Offshore Industry . . . . .	8
1.6 Novel Approach . . . . .	9
<b>2 Dynamic Positioning Operations</b>	<b>11</b>
2.1 Introduction to Dynamic Positioning . . . . .	11
2.1.1 Concept of dynamic positioning . . . . .	11
2.1.2 Degrees of freedom . . . . .	14
2.1.3 Position reference systems . . . . .	15
2.1.4 Dynamic positioning vs. other station-keeping options	18
2.2 Loss of Position and Probability of Accident . . . . .	21
2.3 Emergency Disconnection . . . . .	22
2.4 Consequences of LOP . . . . .	24
2.5 Dynamic Positioning in the Industry . . . . .	24
2.5.1 Classifications of dynamic positioning systems . . . . .	24
2.5.2 Application of dynamic positioning in the offshore in-	
dustry . . . . .	25

2.6	Dynamic Positioning Operator . . . . .	26
2.6.1	Barrier element during LOP incidents . . . . .	26
2.6.2	Decision-making by the dynamic positioning operator . . . . .	28
2.6.3	Training and certification . . . . .	29
<b>3</b>	<b>Arctic Environment and Human Reliability</b>	<b>31</b>
3.1	Arctic Environmental Conditions . . . . .	31
3.1.1	Cold climate . . . . .	31
3.1.2	Light conditions . . . . .	32
3.1.3	Wind and polar lows . . . . .	33
3.1.4	Fog and mist . . . . .	34
3.1.5	Icing and snow . . . . .	34
3.1.6	Sea state . . . . .	36
3.1.7	Mental stress factors . . . . .	37
3.2	Human Reliability . . . . .	38
3.2.1	Human reliability as a series system . . . . .	38
3.3	Arctic Impacts on Human Reliability . . . . .	39
3.3.1	Freezing, mobility and motoric precision . . . . .	39
3.3.2	Balance . . . . .	40
3.3.3	Equipment and tools . . . . .	40
3.3.4	Vision impacts . . . . .	41
3.3.5	Mental and physical condition . . . . .	41
3.3.6	Confined working space . . . . .	41
3.4	Reliability of the Dynamic Positioning Operator Under Arctic Conditions . . . . .	42
<b>4</b>	<b>Quantitative Risk Assessment</b>	<b>43</b>
4.1	Introduction to QRA . . . . .	43
4.2	Use of QRA . . . . .	44
4.2.1	Risk management and decision-making . . . . .	44
4.2.2	Describing risk quantitatively . . . . .	45
4.3	Relevant QRA Techniques . . . . .	45
4.3.1	Event tree analysis . . . . .	45
4.3.2	HAZID . . . . .	46
4.3.3	Fault tree analysis . . . . .	46
4.3.4	Risk acceptance criteria . . . . .	47
4.3.5	Risk matrix . . . . .	47
<b>5</b>	<b>Results and Discussion</b>	<b>51</b>
5.1	Results of the Study . . . . .	51
5.1.1	Fault tree analysis . . . . .	51
5.1.2	Reliability block diagram . . . . .	53
5.1.3	Event tree analysis . . . . .	54
5.1.4	HAZID . . . . .	59

<i>CONTENTS</i>	xi
5.1.5 Risk matrix . . . . .	61
5.1.6 Interpretation and evaluation of results . . . . .	65
5.2 Suggestions for Reducing Risk . . . . .	67
<b>6 Conclusion and Further Work</b>	<b>69</b>
6.1 Conclusion . . . . .	69
6.2 Future Work . . . . .	69
<b>Bibliography</b>	<b>71</b>
<b>Appendices</b>	
<b>Appendix A Effect of wind on sea conditions</b>	<b>77</b>



# List of Figures

1.1	Distribution of main causes for LOP incidents . . . . .	2
1.2	Distribution of secondary causes leading to LOP incidents . .	3
1.3	Location of the new ice edge . . . . .	4
1.4	Definition of Arctic . . . . .	5
2.1	Illustration of the DP drilling operation . . . . .	12
2.2	The barrier elements in DP drilling . . . . .	13
2.3	The hierarchy over major elements in DP operation . . . . .	14
2.4	The six degrees of motion for a MODU . . . . .	15
2.5	Lowest annual temperature around Bear Island . . . . .	17
2.6	Depth layers around Bear Island . . . . .	18
2.7	Severe incidents during DP operations at the NCS 2000-2013	20
2.8	Diagram for classifying safety of DP operations . . . . .	22
2.9	Illustration of the DPO as a barrier element . . . . .	27
3.1	Wind speeds for Ekofisk, Statfjord, Heidrun and Tromsøflaket	33
3.2	Ice predictor nomogram for a constant sea temperature of -1.5°C . . . . .	36
3.3	Significant wave height for Ekofisk, Statfjord, Heidrun and Tromsøflaket . . . . .	37
3.4	Series of tasks in a work process set in system . . . . .	38
4.1	The risk assessment process . . . . .	43
4.2	The most common gates and symbols used for FTA analysis; OR-gate, AND-gate, box for description of event and basic event. . . . .	47
4.3	Example risk matrix . . . . .	48
5.1	Fault tree for the top event “DPO error” by impact of Arctic conditions. . . . .	52
5.2	RBD for the steps to find the probability of the DPO success- fully actuating EQD for the general case. . . . .	53
5.3	RBD for the steps to find the probability of the DPO success- fully actuating EQD for the Arctic case. . . . .	54

5.4	ETA for the initiating event LOP for the Arctic case. . . . .	55
5.5	ETA for the initiating event LOP for the general case. . . . .	56
5.6	Risk matrix for the individual end events for the Arctic case.	64
5.7	Risk matrix for the individual end events for the general case.	64
5.8	Risk matrix for the three main end events for both Arctic and general case. . . . .	65



# List of Tables

3.1	Classification of ice growth based on prediction . . . . .	35
5.1	Comparing the probabilities for blowout in general and for the Arctic case during LOP. . . . .	58
5.2	HAZID based on the main end events 1.1-1.5 observed in the ETA. . . . .	60
5.3	Ranking consequences and probabilities. . . . .	61
5.4	Probability and consequence ranking for each individual event. . . . .	62
5.5	Probability and consequence ranking for the main end events. . . . .	63
A.1	Effect of wind on wave height and sea state. . . . .	78



# Chapter 1

## Project Outline

### 1.1 Output for Reader and Background for Study

In order to get a maximum understanding of this thesis it is a prerequisite that the reader has a background in risk analysis and has experience with the techniques and technical jargon that will be used here. For instance, the project paper written in the preface of this thesis could prove useful as an introduction and provide an understanding of some risk assessment techniques. However, the methods chapter will discuss and define these techniques for the purpose of explaining more thoroughly how they will be dealt with in this thesis.

The background for performing this quantitative risk assessment (QRA) study is to contribute to safer operations performed by mobile offshore drilling units (MODU) using dynamic positioning (DP) systems in Arctic areas. Accidents related to drilling operations in this environment are by numerous studies been proven fatal for health, safety and environment due to the difficult operating conditions as well as the complex and vulnerable ecosystems. The features of the Arctic environment, enhancing the complexity of drilling activities, make information and illumination of important and relevant aspects necessary. Accidents escalating from loss-of-position (LOP) incidents may harm the Arctic environment, in addition to workers and assets, by consequences like subsea and topside blowouts as well as leakage of drilling mud. DP drilling can be considered a dangerous operation as LOPs may occur, which means that analyzing DP drilling is important to investigate how it may develop to a blowout, and how risk-reducing measures can be implemented for increased safety of the operation.

For general concerns of LOP incidents, statistics provided by the International Marine Contractors Association (IMCA) reveal that human errors are the second largest main cause, only beaten by references system, and the third largest secondary cause for LOP incidents, as shown in Figure 1.1 and 1.2. Here, the main causes are defined as “a fault that starts or results in a position loss” and secondary as “causes which could be attributed to the incident or complicate the position loss recovery” [Hauff, 2014].

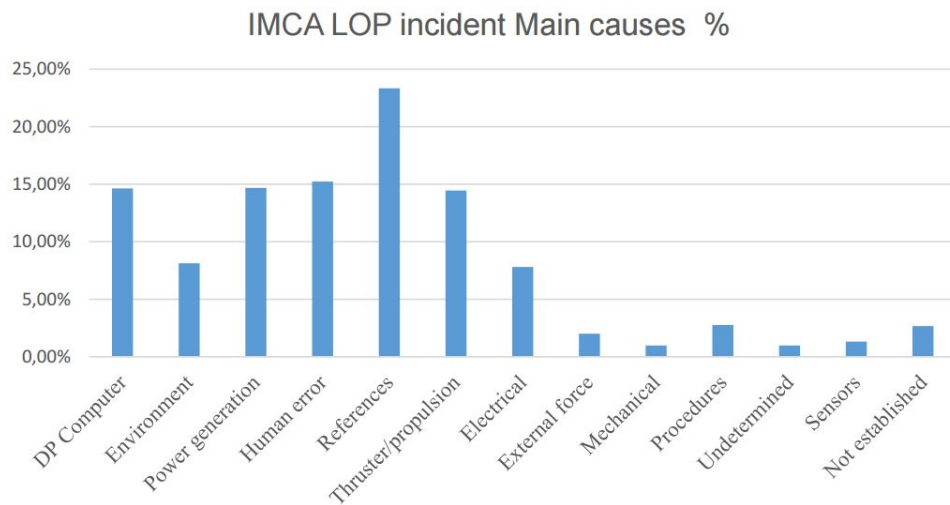

Figure 1.1: Percentage distribution of main causes for LOP incidents based on IMCA data [Hauff, 2014].

The fact that human errors are proven to be such a large contributor to LOP incidents it makes it interesting to pursue more exactly how humans play a part in DP drilling and analyze how their involvement can lead to significant accidents. In this thesis the human factors play a major role when analyzing trigger mechanisms to errors by the dynamic positioning operator (DPO). Because of the distinctive features of the Arctic one can find influencing factors on human workers which are not to be found elsewhere, or not to the same extent. The DPO will not be regarded as an element to trigger LOP, but instead as a barrier element to avoid LOP incidents from escalating into severe accidents.

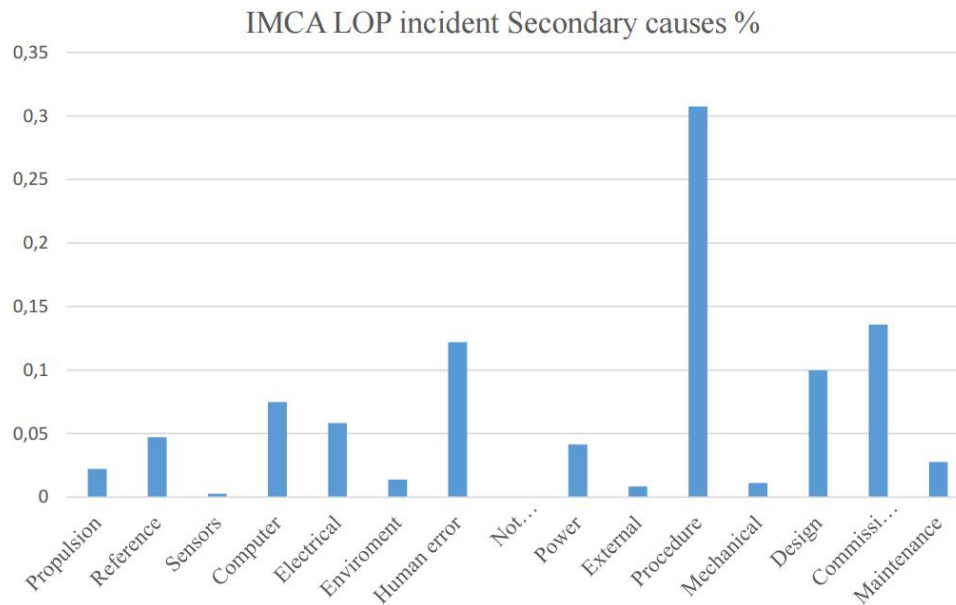

Figure 1.2: Distribution of secondary causes leading to LOP based on IMCA data [Hauff, 2014].

For these reasons an analysis of the DPO and the function as a barrier element during LOP incidents in the Arctic is interesting to carry out, and hopefully it can provide guidance and illuminate new factors for both current and future operations and hence improve their safety.

## 1.2 Scope and Limitation of the Study

### 1.2.1 Scope

The scope of this thesis is to determine how safety of DP drilling by a MODU is affected by Arctic conditions. The main topic will be to analyze how the reliability of the DPO can be affected and explore how this in turn can have an influence on the outcomes during the critical situation LOP. The analysis will be performed through application of QRA techniques to show how these methods can be used for this kind of analysis. Through this it will aim to display how the conditions of the Arctic offshore environment will reduce the safety of the operation by influencing and reduce the reliability of the DPO during LOP. In order to make it possible to perform the analysis it is necessary to get an overview of what kind of features one may likely encounter in the offshore Arctic, how these lead to lower performance by human beings and how this kind of information can be used in a risk assessment. These

elements will therefore be explored before the risk assessment process takes place.

As the oil and gas industry is approaching new areas and the Ministry of Petroleum and Energy announcing the 23rd licensing round with 54 of 57 blocks in the Barents Sea, this area makes it interesting to analyze. The northernmost blocks in this licensing round are located at a latitude higher than 74 degrees north, which is the same latitude as Bear Island. The Norwegian government wants to move the so-called ice edge, defined as the limit for where there is more than 30% probability for sea ice in April, just north of Bear Island, as illustrated in Figure 1.3. For this reason, and the fact that Bear Island has a meteorological station with staffing all year round providing actual data sets, the location will be used as a reference point for this thesis.

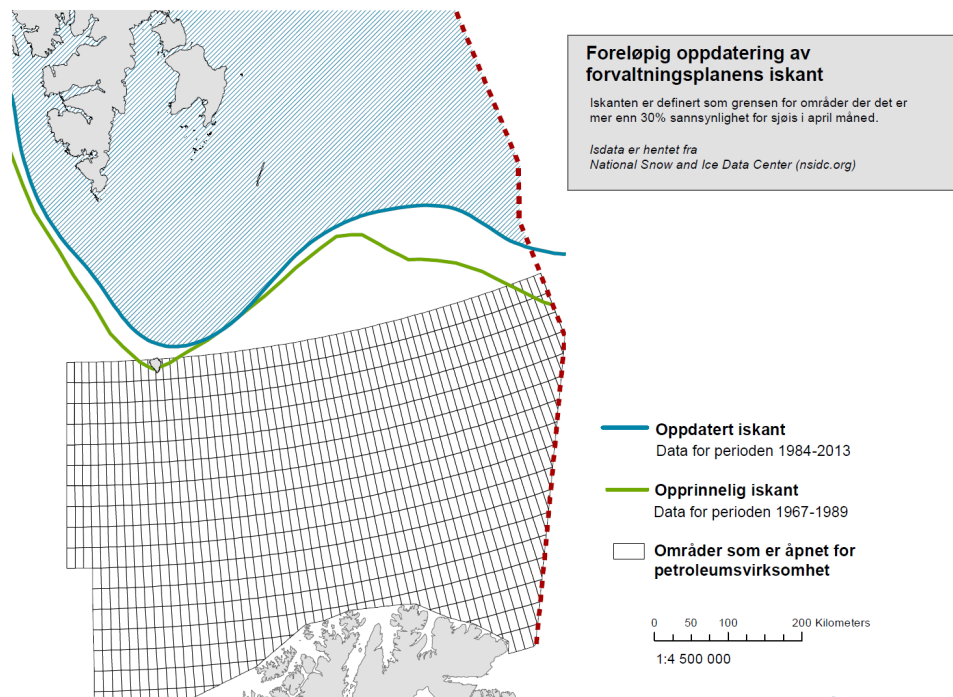

Figure 1.3: The previous ice edge in green passing over Bear Island and the updated ice edge proposed by the Norwegian government in blue [The Norwegian Government, 2015].

## Definition of Arctic

Over the years, several definitions of Arctic has been made to fit the various demands. In order to make it possible to discuss features important for



this project it is important to decide for an appropriate definition. The areas north of the Arctic Circle located at about  $66^{\circ}\text{N}$  seems to be the most suitable definition, as it is the limit for some of the factors that will be up for discussion later on. In Figure 1.4 the definition of Arctic areas that will be taken into consideration is illustrated.

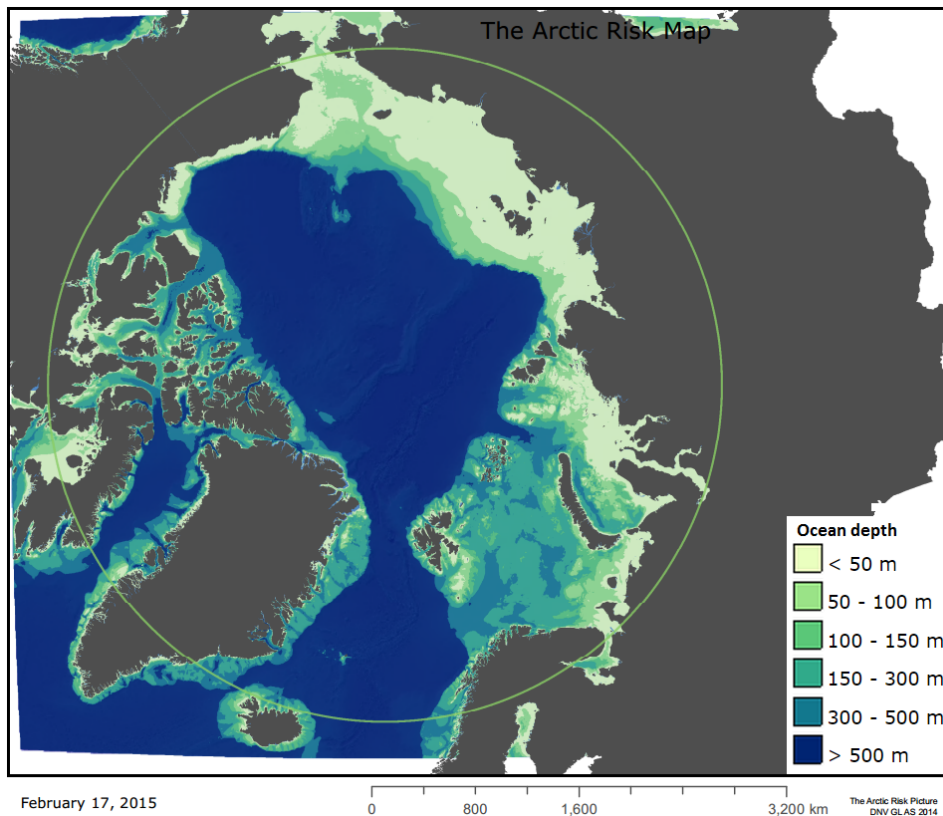

Figure 1.4: Definition of Arctic. [DNV GL, 2015c]

The circle is the location of the Arctic Circle, whereas the gray areas are land, which will not be discussed in this project. The areas north of this point cover about 6% of the total surface of the Earth, where approximately 2/3 of these areas are located offshore [Fridtjof Nansen Institute and DNV, 2012].

### 1.2.2 Limitation of study

To prevent the thesis from grasping over a too large field of study it is important to set some clear limitations and precisely define what it is supposed to encompass. Remark that the limitations are set to keep the main focus on the DPO and the QRA process and prevent the thesis from developing

into a populist article, so that it remains a scientific research study.

How the Arctic conditions could further increase the effect of accidents, such as blowouts, could have been performed by utilizing a sensitivity analysis. For instance, winds, waves and currents will faster spread crude oil over large areas, while presence of sea ice has the possibility of limiting the dispersion range. A study of how Arctic conditions might have effects on how these consequences would further escalate for certain areas could have been provided, but this will only be presented to a very limited extent.

Each individual well drilled will have its own specifications and blowout potential, like possible rate of released hydrocarbons per day and location of the drilling activity with regards to remoteness to sensitive areas and oil spill response facilities. Because this study takes Arctic quite generally into consideration and no specific well is considered these are characteristics that will not be taken into account.

The effects of releases of hydrocarbons and drilling muds will not be thoroughly investigated as this is not what the thesis is really about. The Barents Sea possess rich fish resources because of the warmed up water from the Gulf Stream, which will be harmed significantly by such pollution, this is somewhat illustrated in the analysis section, but will not be discussed further. An analysis of how a specific area would be harmed would provide an important element for settling how e.g. fisheries are influenced by release of toxic dispersant which would enhance the reliability and comprehensiveness of the QRA. However, the scope of this thesis remains to look into the effects of Arctic conditions on the DP system and DPO in particular, so the discussion of environmental impacts will only be briefly performed.

During LOP scenarios there is normally a risk for the MODU to crash into surrounding vessels or installations in addition to grounding. In the analysis this is not calculated for because of the extra complexity, but for real-case scenarios this should, without hesitation, be considered as a hazardous situation. The consequences of the LOP scenario will instead be covering whether there is a blowout, if it is topside or subsea, possible leakage of drilling mud, a combination of these, or no hydrocarbon release or leakage of drilling mud at all.

The quality of the software and hardware for systems handling DP operations is by far an important factor when examining robustness of operation. Nevertheless, as it will be complex and too comprehensive to analyze specific computer systems from top to bottom and include this in the QRA it will not be performed. On the other hand, conditions which are unique for the Arctic that might influence the DP system will be discussed, in addition to how these conditions will effect workers.

### 1.3 Organization of Thesis

Including this chapter, the thesis consists of six chapters.

Chapter 2 will define dynamic positioning systems and discuss the parts of it relevant for the analysis.

Chapter 3 examines Arctic conditions and discusses how they can influence the reliability of human workers.

Chapter 4 explains how the methods in quantitative risk assessment are interpreted and explains the techniques that will be used in the analysis.

Chapter 5 applies the quantitative risk assessment techniques based on the previous chapters to investigate how Arctic conditions will influence the consequences of a LOP incident, by especially examining the dynamic positioning operator.

Chapter 6 is the conclusive part of the thesis where suggestions for further work on the subject are also proposed.

### 1.4 Data Collection and Relevant Databases

As DNV GL has been an important collaborator to this thesis, gathering of data and information of a large extent is acquired through their databases, internal and external sources. Many definitions and views on different aspects are based on their research and experience with risk assessments as well as their knowledge regarding Arctic conditions and how to apply the available information in the correct manner. Through their expert opinions with conversations, discussions and meetings with their consultants there have been some advantageous illumination of aspects and valued point of views.

Common for many types of risk assessments related to the Arctic is the problem that there is a small amount of operational data available, and although the areas can seem quite similar when assessed geographically, the differences between them when moving from one area to another can in fact be large. IMCA collects data on DP operations, but there are no requirements for reporting incidents, which means that the data collection is based on volunteer contributions by companies. Over the years there have been modifications for how to report incidents and companies use different definitions for technical terms like LOP, which contributes to excess uncertainty. Furthermore, the technological leap for DP systems hampers the quality of data sets as the evolution changes properties and specifications for these.

For analyzing and quantifying the environmental risk factors it is possible to gather both historical, live and prognosis data from weather services like the Norwegian Meteorological Institute. Temperature, daylight, precipitation, wind, and the related wave height are all physical variables that can be collected. It is possible to quantify the impact of these by use of some definitions and calculations. Some of these will be explained later on in the thesis, but to actually use the data practically in the QRA will not be provided in this thesis.

Based on literature studies as well as discussions and consultations with people with expert knowledge on the topic, along with personal judgments and opinions the qualitative and quantitative justifications for this thesis have been achieved. The reasons discussed in this section contribute to emphasizing the fact that there are large uncertainties for the known statistics and data available for this thesis, and this will be reflected in the results chapter.

## 1.5 Previous Work on the Subject

### 1.5.1 QRA and HRA in the Offshore Industry

QRAs have been performed in the oil and gas industry since the late 1970s in Norway, and the techniques are today considered a major part in analyzing and managing issues related to health, safety and environment. Norway was for a long time the only country to systematically implement QRAs, and in 1981 the Norwegian Petroleum Directorate (NPD) announced guidelines for evaluating safety on platform concepts. Almost ten years later it was recommended by Lord Cullen in the report concerning the Piper Alpha accident in 1988 to implement QRAs in the UK legislation as well. In 1992 the Safety Case Regulations entered the UK, and it has since then been mandatory to perform risk assessments in UK offshore industry to take care of safety issues [Vinnem, 2007]. In certain areas where there are little operational data, like in the Arctic, the models have limited capacity with regards to accuracy, but they are still very valuable for improving designs and concepts. Today, several companies base their business on executing QRAs by requests by oil and gas companies.

The significant part humans play in human-machine systems has been proven by the history of accidents where human failures have led to severe outcomes. The Piper Alpha accident in 1988 (167 casualties) and the Exxon Valdez oil spill in 1989 (huge environmental impact) are some of the well-known catastrophes where human errors contribute significantly to the root causes [Bai, 2003]. In Bai [2003] there is cited a study from 1994 which claims that

about 65% of the catastrophic accidents related to marine operations are compounds of human and organizational errors. This reasons for why there is a need for assessing the human contributions to accidents to cover other topics than only the systems and processes in a traditional risk assessment, so these can also be identified and managed.

## 1.6 Novel Approach

To the author's best knowledge no identical type of analysis of a DP system with emphasis on the tasks of the DPO during LOP has been carried out before, but somewhat similar analyzes have been published. Nevertheless, this should be considered as a very simplified approach for safety of DP operations as there are a numerous limitations and it is considered for a very general case of Arctic. It should not be taken as a specific solution for analyzing neither DP system nor DPO, but it could provide a basis for performing more comprehensive studies.





## Chapter 2

# Dynamic Positioning Operations

### 2.1 Introduction to Dynamic Positioning

#### 2.1.1 Concept of dynamic positioning

The term dynamic positioning is defined by Schlumberger's Oilfield Glossary as "The stationing of a vessel, especially a drillship or semisubmersible drilling rig, at a specific location in the sea by the use of computer-controlled propulsion units called thrusters(...)" [Schlumberger Limited, SLB, 2015]. DP is widely in use for when a floating unit is supposed to stay in a specific location or when relative movement between objects is the matter. This is often the case for MODUs, floating production storage and offloading (FPSOs) units, supply vessels, shuttle tankers, etc. in the industry, but also for cruise ships and megayachts where mooring is not possible due to too large depths or difficult seabed conditions, or DP simply seems to be the most appropriate option. The only factor DP depends on with respect to seabed conditions is the water depth.

The most important forces acting on a DP vessel are wind, waves and current, which the DP system will need to cope with to maintain its required position. By measuring the forces acting upon a DP vessel, the computers will calculate and equalize the forces in opposite directions to maintain the position, and when possible turn the vessel in a direction in which it will be least affected. The event LOP occurs when the forces acting upon the vessel are so strong that the thrusters cannot handle them, thrusters lose power, sensors measuring the acting forces are incorrect, computers calculating for the acting forces are not performing or the position reference system is pro-

viding incorrect information. Figure 2.1 shows a brief overview of how a DP operation is performed.

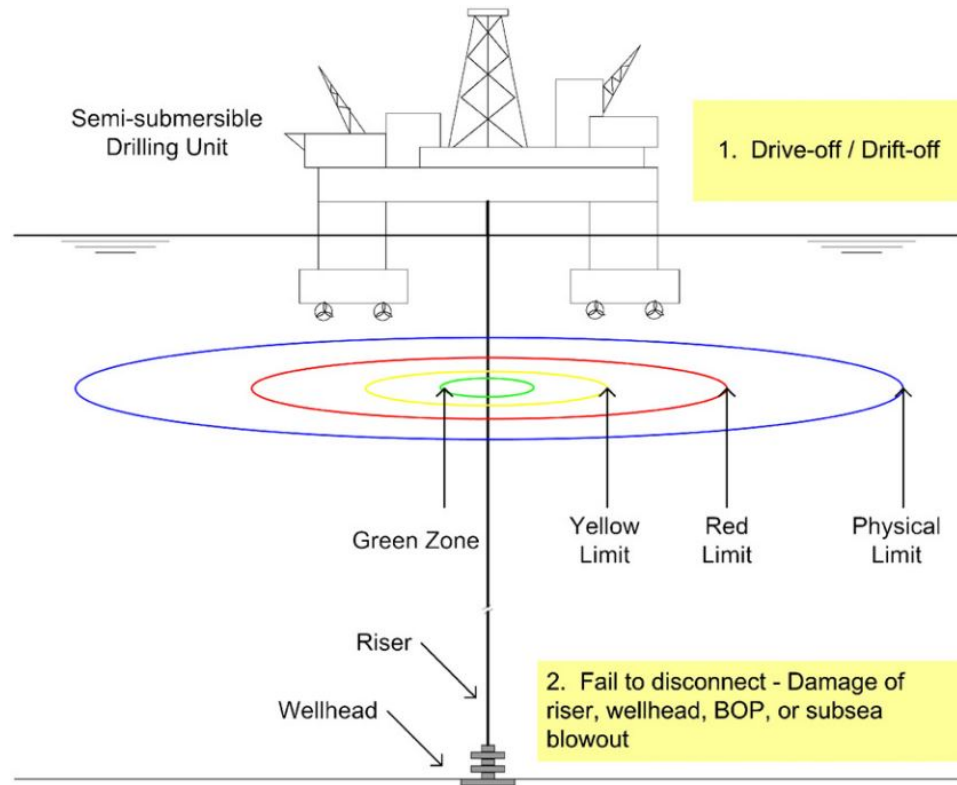

Figure 2.1: Brief overview of the DP drilling operation with limits green, yellow and red, which are not set to scale [Chen et al., 2008].

Related to Figure 2.1 and Figure 2.2, DP drilling is normally performed within the green zone. If the vessel passes the yellow limit while drilling, the drilling operation needs to be terminated and the DPO prepare for an emergency quick disconnection (EQD). Should the vessel continue to drift off and exceeds the red limit, EQD must be initiated in order to shut in the well and disconnect the lower marine riser package (LMRP). The physical limit in blue is where the MODU has drifted so far that the physical constraints acting on the configuration of blowout preventer (BOP) and riser is so high that it will bend or break. This could lead to loss of well integrity and escalate to a subsea blowout if the EQD has not been properly completed. An unsuccessful EQD may also lead to other severe damages on wellhead or riser, leakage of polluted drilling mud, MODU drifting off into surrounding vessels or grounding [Chen et al., 2008].

There are three main barrier functions related to the safety of DP drilling operations [Chen et al., 2008]:

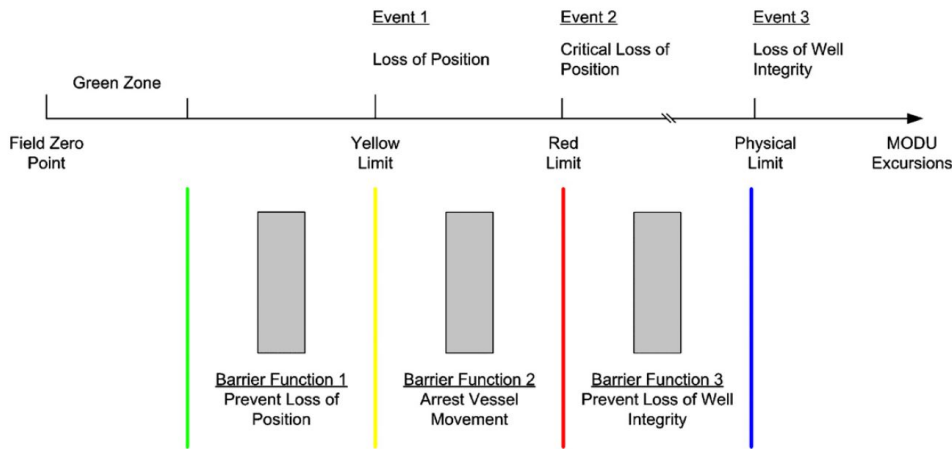

Figure 2.2: The barriers safeguarding DP drilling [Chen et al., 2008].

1. to prevent loss of position.
2. to arrest vessel movement.
3. to prevent loss of well integrity.

These barriers are illustrated in Figure 2.2, which shows where in the trajectory of events each of the barriers has their function.

The purpose of a well-functioning DP system on a MODU if LOP occurs is to both shut in the well and disconnect the riser, given that the MODU will not retrieve its initial position. If this is not done properly, the consequences might be damage on riser, wellhead, BOP or other adjacent installations or — worst case scenario — an uncontrolled blowout with the adverse effects that follow [Verhoeven et al., 2004].

Verhoeven et al. [2004] points out that DP operation is an interaction between humans and machines and identifies five parts a DP system needs to possess: DP control system, reference system, power system, thruster system, and DP key personnel. Thus, when improving safety of DP operations every part of the system needs to be taken into account, which means not only the technical system, but also errors related to human operators and interactions between the human system and the technical one. As there have been considerable improvements of the technology of DP operations there is a need to assess improvements of other parts of the system, like the human factors. The pyramid in Figure 2.3 shows the hierarchy over the major elements that DP operation comprehend.

The figure reveals that a DP system consists of many subsystems which will need to work together for it to function. It is from this figure also noteworthy that the DPO plays the important role of both interact with the hardware

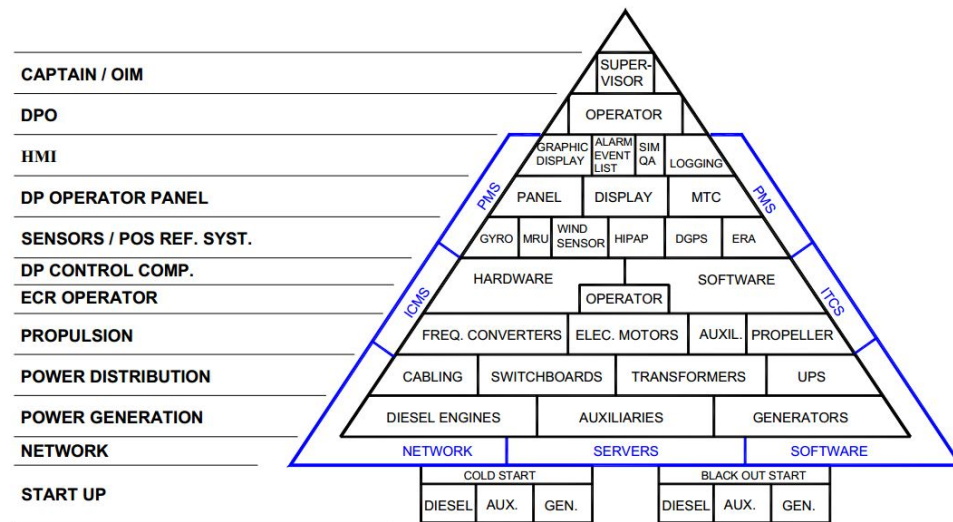

Figure 2.3: Hierarchy over the major elements in DP operation [Verhoeven et al., 2004].

and software while at the same time being the second highest level in the hierarchy, only beneath the supervisor or captain.

### 2.1.2 Degrees of freedom

A MODU will have six degrees of freedom which forces will be working on. These are linear motions by the x-, y- and z-axis and corresponding angular motions to each of those. The motions are defined as follows [DNV GL, 2015b]:

- x-axis: *surge* is the linear motion and *roll* is the angular motion
- y-axis: *sway* is the linear motion and *pitch* is the angular motion
- z-axis: *heave* is the linear motion and *yaw* is the angular motion

This is illustrated in Figure 2.4 with a sketch of the hull of a ship.

Traditionally, only linear movements in the xy-plane; surge, sway and yaw, are expected to somehow be controlled by DP systems. However, a study by Jenssen (2010) reveals that motions pitch and roll can be dampened by using thrusters to reduce the natural low frequencies of MODUs. The study claims that the large pitch and roll motions are most likely a consequence of low frequencies caused by resonance between hull and DP system combined with the wave frequency. It is realistic that improvement of 10 times in

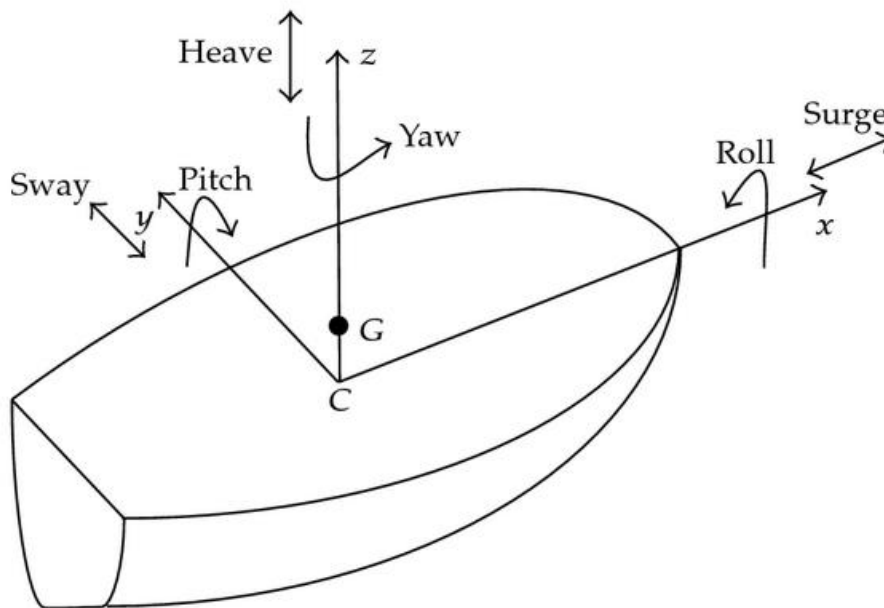

Figure 2.4: Schematic illustration of the six degrees of motion for a MODU [Ibrahim and Grace, 2010].

relative damping is possible to achieve if the pitch rate control is adequately tuned [Jenssen, 2010].

### 2.1.3 Position reference systems

For a MODU to maintain a specific location it will need some sort of reference system which should be quite accurate. In general, the traditional reference systems used in the industry will not be accurate enough for MODUs, which is why other reference systems have been developed. The position reference systems can be divided into absolute and relative positioning systems. The difference between these is that the absolute systems will give a geographical location, while the relative systems gives the position related to a reference which is normally not fixed. However, a relative system can be considered an absolute system if the reference points are geographically fixed [DNV GL, 2011].

DNV GL has determined the most commonly used absolute and relative position reference systems in use [DNV GL, 2011]:

Absolute:

- DGNSS (DGPS and GLONASS)

- Acoustic (USBL, SBL and LBL)
- Taut wire

Relative:

- Artemis
- Laser (e.g. Fanbeam , Cyscan)
- Radar (e.g. RADIUS, RadaScan)
- DARPS

Because the position reference system is a crucial part of DP operations, DNV has developed different class notations for DP systems to set minimum requirements for specific operations. The accuracy of position reference systems is by the guidance of DNV set to 2% of the water depth for bottom-based systems and a radius of 3 m for surface-based systems [DNV GL, 2014].

### Common reference systems in the Arctic

As there are several possible reference systems available on the market where each has its own specifications and limitations, it will be important to choose reference systems suitable for the requirements of each operation. For Arctic, exclusively, there are several special conditions that will have an impact on the reliability of the position reference systems. Such conditions are weather conditions, satellite coverage and the effect aurora borealis has on satellite signals.

A study performed by Rinnan [2012] concerning use of Global Navigation Satellite System (GNSS) in the Arctic reveals some interesting facts. For instance, a typical GNSS antenna is said to work fine down to  $-40^{\circ}\text{C}$ . In the Arctic the average January temperatures range from about  $-40^{\circ}\text{C}$  to  $0^{\circ}\text{C}$ , so GNSS will mostly work fine under the Arctic temperature conditions. In reference to Figure 2.5 Bear Island is located just north of the  $-20^{\circ}\text{C}$  marking, which means the temperature will not pass  $-30^{\circ}\text{C}$ , and thus GNSS is in the safe zone by means of temperature.

The study further claims that snow does probably not have a substantial effect on GNSS antenna, while the effect ice-loads have is quite unknown. Though, a case study was performed by O’Keefe et al. [1999], cited in Rinnan [2012] about the effect an ice load will have on GPS antennas conclude that a wet surface ice load of 1.25 cm will have undesirable effects. The signal-to-noise ratio (SNR) will be decreased with 3 dB and there will be an increase in the rms position error of 1 m in addition to the number of cycle slips.



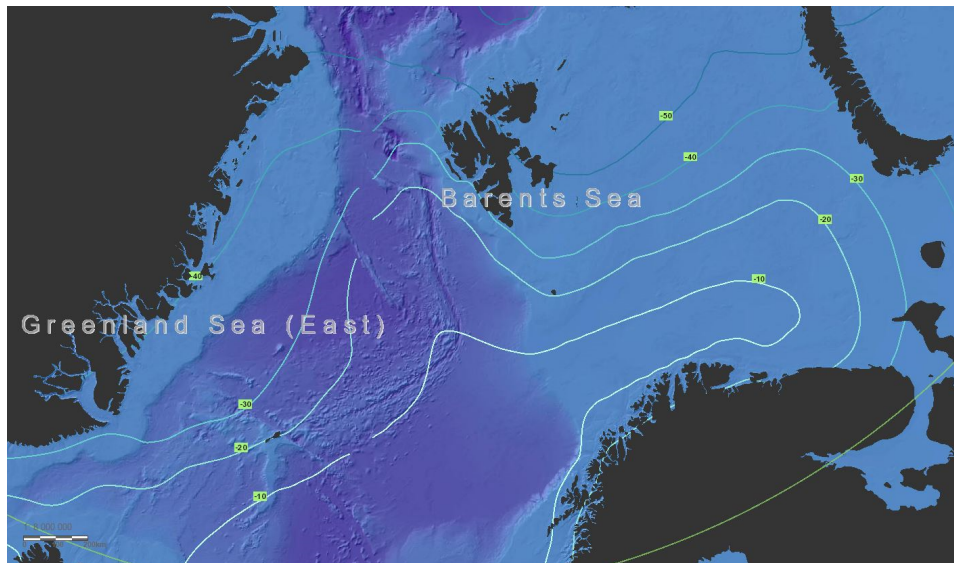

Figure 2.5: The lowest extreme temperatures annually for Bear Island and surroundings [DNV GL, 2015a].

With regards to GNSS satellite coverage, Horizontal Dilution of Precision (HDOP) improves at the high latitudes in addition to the number of visible GNSS satellites. GEO satellites are commonly used for differential signals and communication, but this type of satellites has a limited availability in the Arctic. The reason for this is that additional margins needs to be taken because of signal disturbances from solar activities, roll movements and that GEO satellites are more vulnerable to obstructions in general due to their increased distance to the Arctic. It is suggested that a system based on a combined satellite constellation of both manners will prove to be the best choice to improve reliability of the position reference system in total [Rinnan, 2012].

Aurora borealis is the phenomenon that arises when energy-filled particles from the sun are flung towards the ionosphere in the upper atmosphere of the Earth, where they are influenced by the magnetic field and directed towards areas around the magnetic poles [Vitensenteret, 2015]. The solar activity relates to the sun spot cycle, which vary from eight to fourteen years in range [Fox, 2011]. The current cycle started early in 2008 and is sunspot cycle number 24 since the first cycle was recorded in the middle of the 18th century. With high solar activity one can expect high auroral activity and there are related effects from this on GPS systems. For GNSS, the accuracy decreases during such ionospheric activities, and GEO satellites experience loss of signals [Rinnan, 2012].

### 2.1.4 Dynamic positioning vs. other station-keeping options

#### Depth

With regards to depth, DP is independent of it for keeping in position. In fact, safety of DP operations can be discussed to be improved with depth as it will lower the probability for the DP vessel to ground. Also, with larger depth the allowable offset of 2% of the water depth will increase and the DP operation will have a larger surface area of operation. On the other hand, other position-keeping solutions such as jackup and mooring depend on waters being shallow enough for having the possibility to attach to the seabed. For instance, the DNV GL classified jackup from Mærsk called Mærsk Inspirer is one of the largest jackups in the world, but can only operate in water depths up to 150 m [Maersk Drilling , 2014]. In Figure 2.6 the depth layers around Bear Island are illustrated, and it is worth noticing that one will not need to travel farther than 100 km towards west from Bear Island to find depths exceeding 500 meters. For the matter of Mærsk Inspirer it will be enough to travel 30 km from Bear Island to find water depths exceeding 150 m.

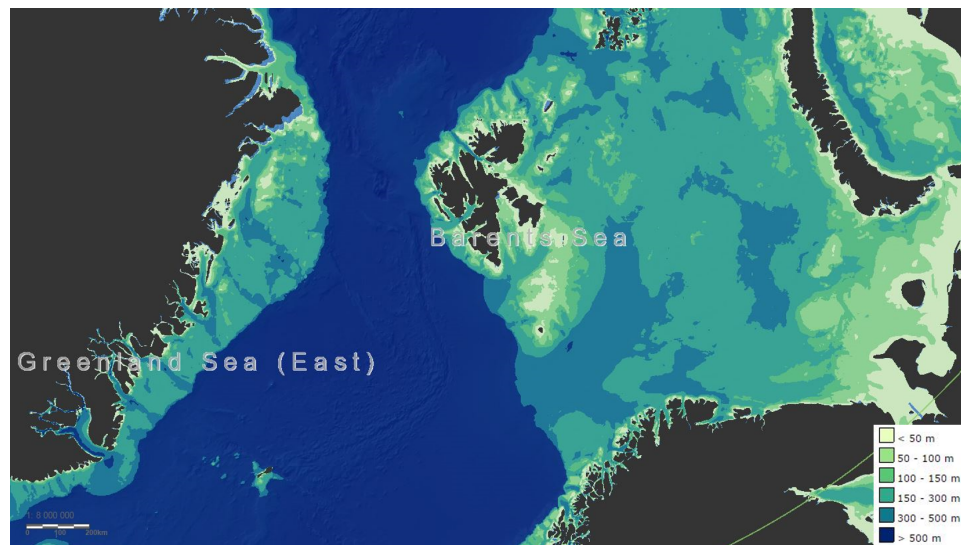

Figure 2.6: Depth layers around Bear Island [DNV GL, 2015a]

#### Seabed conditions

As DP is not attached to the seabed, this does not need to be taken into account for the position-keeping part of operation. Jackups and mooring both depend on the seabed conditions as they need to be suitable for an-

choring etc. If the seabed is obstructed by pipelines or natural features like coral reefs or some sort of marine geohazards, jackup and mooring might be difficult to use and DP will in this case have a clear advantage.

### **Subsurface dangers**

Propellers and thrusters working to maintain a preferred location will cause a danger to subsurface activities taking place during DP operation. Such activities can be diving and operating remotely operated vehicles (ROVs), but it may also be a danger to fish and other living organisms in the sea. Moreover, use of engines will consume fuel and emit CO<sub>2</sub> which pollutes the environment. The other position-keeping options have only static equipment subsurface, which will not put the mentioned issues at risk to the same extent.

### **Maneuverability**

Considering the maneuverability aspect of drilling operation, DP drilling is without doubt the most efficient solution. With DP one can move relatively quickly from one place to another, without need for taking care of anchors or jacks. This saves a great deal of travel time for the rig and is therefore a cost-effective solution for this concern.

### **Operational conditions and environmental loads**

The most important environmental forces acting directly on a MODU are winds, waves and currents. For jackups, the rig itself is elevated so much that waves and currents will not reach it, but only be acting on the jacks. A floating MODU, like a drillship, on the other hand will be more prone to these forces as they will be in direct contact with the hull. When mooring is used, one will also need to take into account marine growth, tide and storm surge, earthquake, temperature, snow and ice in addition to other effects which may be relevant for the specific location [DNV GL, 2010a].

In DNV GL [2014] it is explained how to calculate environmental regularity numbers (ERN) which are used for evaluating position holding capability for DP vessels under certain conditions. The calculation takes input values of winds, waves and currents, assuming their forces are coincident in direction, and provides a corresponding ERN number based on what forces the DP vessel is capable to withstand. In reference to Table B1 in DNV GL [2014], a higher ERN result represents a better ability to withstand environmental

forces. As for mooring, the same environmental loads needs to be assessed to get a sufficient overview of the environmental conditions. Chapter 3 will go more into depths of the environmental factors DP drilling operations that are likely to face in the Arctic offshore.

### Accidents related to floating position-keeping operations

At the Norwegian continental shelf (NCS) there have been reported accidents at vessels handling mooring equipment in years 1996, 2000 and 2001, giving a significant frequency of accidents. Even though there have not been any deadly accidents since 2001, there have been incidents almost resulting in death as late as in 2011 [Petroleumstilsynet, 2014].

For DP operations, the number of severe incidents at the NCS from years 2000 to 2013 is 16, where an incident is considered severe if it is a drift-off, drive-off, force-off, or if there is loss of more than one thruster used for DP operation. The distribution of these incidents is given in Figure 2.7.

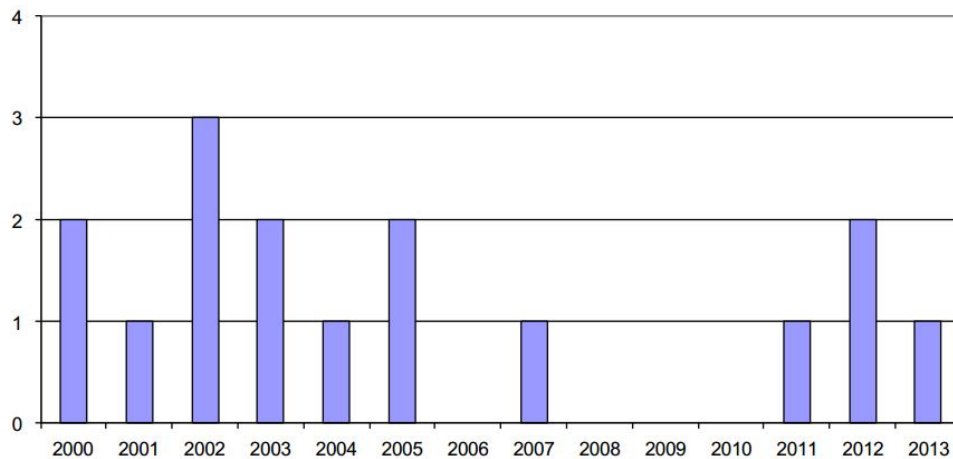

Figure 2.7: Number of severe incidents during DP operations at the NCS 2000-2013 [Petroleumstilsynet, 2014].

### Dynamic positioning vs. mooring

To sum up, for operations where depth and seabed conditions are suitable for mooring, this should be considered as a better alternative than DP. This is in lights of economy and environment as the DP system will consume fuel and pollute while keeping the MODU in position, while mooring positions the MODU without such adverse effects. It is becoming more common for DP vessels to have both DP and mooring as possible solutions for

position-keeping. This gives the DP vessel more opportunities for operating environment, and can provide a more cost-efficient operation and less pollution if mooring can be used instead of DP mode for a longer period. In addition, there is expected to be higher consumption of fuel to maintain position in the Arctic because of greater rolling resistance [Markeset, 2013]. Nevertheless, a MODU which is supposed to perform multiple tasks within a relatively short area will be more efficient in repositioning.

## 2.2 Loss of Position and Probability of Accident

LOP can be divided into two different scenarios; drift-off and drive-off. A drift-off occurs due to loss of power so the vessel drifts away from its intended position. A drive-off is the situation where the DP system adjusts the position incorrectly, commonly due to erroneous position reference input which causes the DP system to believe it is not in its preferred position [Shi et al., 2005].

The DP incident data reported for 2001 to IMCA<sup>1</sup>, cited in Verhoeven et al. [2004], reveals that the probability for LOP for DP vessels in general had a quantity of  $10^{-5}$  for each hour of operation, or about  $10^{-1}$  to  $10^{-2}$  per year for each vessel. When analyzing the causes for LOP, the DP operators and computers proved to be the main contributors. It should be remarked that the data are from DP operations in general and do not specify classification of DP vessel, geographic location or environmental factors, but they still display which branches of DP operation that will need attention for improvement measures [Verhoeven et al., 2004].

Figure 2.8 illustrates how safety of DP operations can be classified.

To calculate this safety, a simplified approach for calculation of probability for an accident from LOP for MODUs is presented by Chen [2003] and adapted in Verhoeven et al. [2004]. The adapted model takes into account the probability of LOP and the probability of failure of recovery given LOP to find the overall probability of an accident, as shown in Equation 2.1.

$$P(\text{Accident}) = P(\text{Failure of Recovery}|\text{Loss of Position}) \times P(\text{Loss of Position}) \quad (2.1)$$

This is a general probabilistic model where all of the probabilities are variables to each specific operation. One will need to know the conditions the MODU will be performing under and the reliability of the whole DP system under these conditions to have a baseline for determining the probability of

<sup>1</sup>IMCA: "Station Keeping Incidents Reported for 2001", IMCA M 169, February 2003

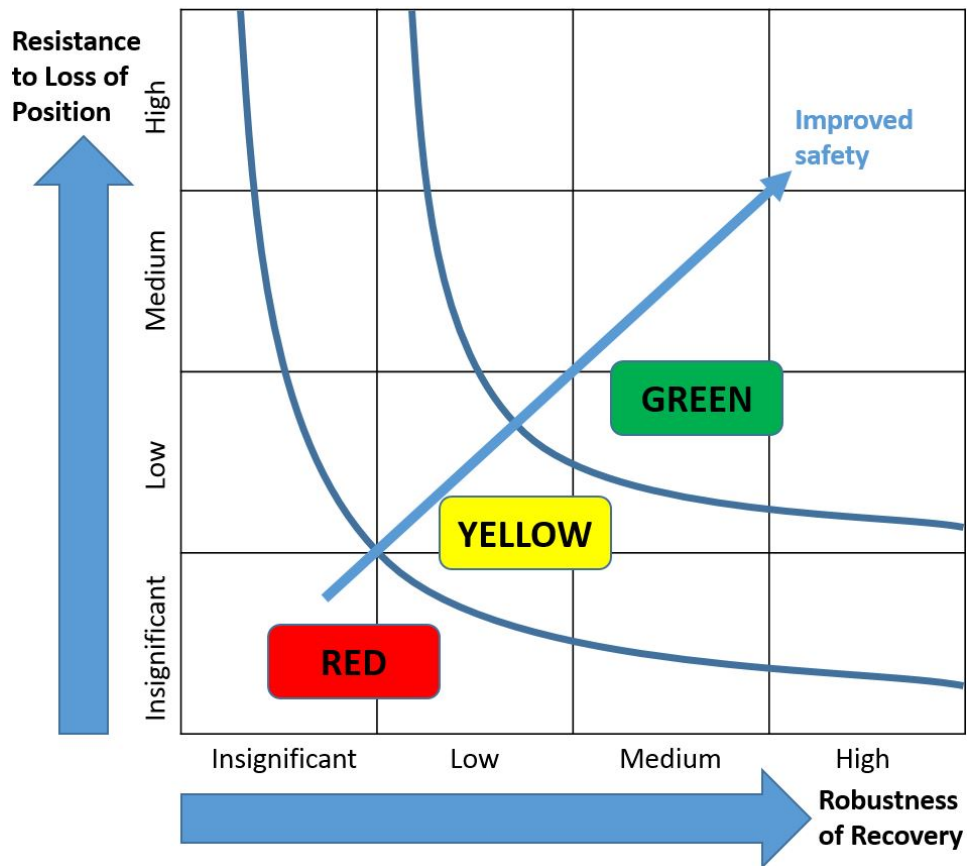

Figure 2.8: Diagram for classifying safety of DP operations [Verhoeven et al., 2004].

accident for a specific case. The calculation of probability of accidents in the results chapter adds all of the individual probabilities together to find the overall probability of accident from LOP by the following equation:

$$P(\text{All accidents from LOP}) = \sum_{i=1}^n P_i = P_1 + P_2 + P_3 \dots + P_n \quad (2.2)$$

### 2.3 Emergency Disconnection

As mentioned in 2.1.1, EQD is the sequence initiated when the MODU exceeds the red limit and the riser or LMRP will need to be disconnected from the BOP in order to prevent loss of well integrity. The sequence commonly involves about 15-20 steps, where the major one are [Chen et al., 2008]:

- Cut pipe inside the BOP by the casing shear ram (if it is available).
- Retract the LMRP connectors from the BOP.
- Lift-off of the LMRP from the BOP.

Basically, there are two main types of EQD systems; manual or auto EQD. Manual EQD relies on the DPO or driller to initiate the EQD sequence in time so it is completed before it reaches the physical limit. Auto EQD depend on the estimated position of the MODU from the DP software and given that this information is correct, it will conduct the EQD sequence within the required time. The total available time for the EQD sequence is given in Verhoeven et al. [2004] and shown in Equation 2.3.

$$\begin{aligned} \text{Total available time} &= \text{Time available to initiate EQD} \\ &+ \text{Time needed for EQD sequence} \end{aligned} \quad (2.3)$$

The total available time depends on the allowable offset and speed of the MODU in the LOP situation. Allowable offset depends on the water depth and the angle limitation of the arrangement of riser and BOP. Commonly, the EQD sequence needs to be completed before the lower flex joint reaches an inclination of  $8^\circ$ , which corresponds to an allowable offset of 70 m in a water depth of 500 m [Verhoeven et al., 2004]. The allowable offset will increase with depth, given that the same riser angle limitation is used. In the analysis of this thesis it is assumed that auto EQD is not available for the fictional MODU and that only the DPO may actuate manual EQD.

If the EQD sequence seems to be activated too late, it is on some installations possible to benefit from a feature called safe disconnection system (SDS). The sequence is predetermined to be triggered when the riser angle exceeds a certain level of inclination and the EQD still has not been fully completed. The SDS sequence does not depend on signals or live actions from the surface, but will launch by itself. It disconnects the riser or LMRP from the BOP and actuates the BOP rams to close shortly after the disconnection. It is recommended that SDS is installed in addition to EQD systems to work as a supplement and hence increase the number of barrier elements in addition to enhance safety of DP drilling operation [Chen et al., 2008].

A possible failure mechanism common for EQD and SDS is failure of the well shut-in function. There are located two possible methods for this; technical failure of the system used for well shut-in or when there are non-shearable items in the BOP. However, as there were registered no failures of the well shut-in function at the NCS up to February 2006, this seems like a rather unlikely situation [Chen et al., 2008].

## 2.4 Consequences of LOP

Consequences of LOP vary depending on the installed safety systems, the environment and other relevant circumstances. When the yellow limit is passed during drift-off, the MODU will still have the possibility to retrieve thruster power, and for a drive-off event the reference system may be able to provide correct position data again and move back to a wanted position. If the MODU is not able to recover from LOP and reaches the red limit, EQD or other safety systems should preferably be actuated. If everything goes well in the EQD sequence the BOP shuts in the well while the LMRP is disconnected. But if the EQD and other safety systems prove to be unsuccessful or they are not enabled, severe consequences may occur. Damages on wellhead, BOP or riser are likely to happen, and this can lead to blowouts both subsea and topside in addition to leakage of drilling mud. The MODU may also aground or crash into other ships like stand-by vessels and supply ships. All of these events during unsuccessful recovery situations are hazardous situations which may lead to undesirable environmental impact and damage on assets and are a threat to the personnel. The event LOP will be analyzed by an event tree analysis later to see what kind of premises which will need to set for having release of hydrocarbons and leakage of drilling mud.

## 2.5 Dynamic Positioning in the Industry

DP is a valuable tool as it is used as a solution for several different operations in the oil and gas industry, but it is also in use by other installations which need to keep position or be in relative movement. Cruise ships, marine research vessels, mine sweepers and dredgers are all examples of vessels in other industries which benefit from DP.

### 2.5.1 Classifications of dynamic positioning systems

There are different notations for classification of ships with DP systems established by various instances. The International Maritime Organization (IMO) divides the equipment classes into three levels by the guideline IMO MSC/Circ. 645 "Guidelines for Vessels with Dynamic Positioning Systems" which are defined as follows [The Maritime Safety Committee, 1994]:

1. For equipment class 1, LOP may occur in the event of a single fault.
2. For equipment class 2, a LOP is not to occur in the event of a single fault in any active component or system. Normally static components



will not be considered to fail where adequate protection from damage is demonstrated, and reliability is to the satisfaction of the Administration. Single failure criteria include:

- Any active component or system (generators, thrusters, switchboards, remote controlled valves, etc.).
- Any normally static component (cables, pipes, manual valves, etc.) which is not properly documented with respect to protection and reliability.

3. For equipment class 3, a single failure includes:

- Items listed above for class 2, and any normally static component is assumed to fail.
- All components in anyone watertight compartment, from fire or flooding.
- All components in anyone fire sub-division, from fire or flooding.

It should from this be clear that DP vessels with equipment class 3 possess the most redundant DP systems, followed by equipment class 2 and then 1. Note that the classifications does not tell what kind of operation the DP vessel is equipped for, only how redundant the DP system is with regards to failures. The IMO equipment classes 1, 2 and 3 correspond to the class notations DNV GL operate with, respectively DPS 1, DPS 2 and DPS 3 [DNV GL, 2014]. The DP equipment class required for each operation may be agreed between owner of the vessel and their respective customer. However, some countries set requirements for DP equipment class for operations taking place within their territory, taking into account the type of operation [DNV GL, 2012]. For instance, Petroleum Safety Authority Norway (PSA) requires units performing drilling operations to have the highest level of classification, DP class 3, while there exists no requirements for the US part of the Gulf of Mexico per August 2010 [DNV GL, 2010c]. DNV GL recommends minimum DP class 2 for drilling operations [DNV GL, 2011].

### **2.5.2 Application of dynamic positioning in the offshore industry**

In addition to drilling units, DP is used in the oil and gas industry for other units which will need to stay at a fixed location, follow a predetermined track or be in relative movement. Flotels, supply vessels, seismic survey vessels, and pipe laying vessels are typical units where DP is installed [Kongsberg Maritime]. The largest flotel legal to operate in Norway,

Safe Boreas, have both a 12-point mooring system and DP with DP class 3 installed as position-keeping options [Andersen, 2015].

Offshore operations using DP in the Arctic are currently taking place and are also planned for the future. Scarabeo 8, owned by Saipem, is a semi-submersible drilling rig which is drilling production wells on the Goliat field in the Barents Sea for ENI. It can be positioned by mooring down to 1000 m of depth, but it also has DP as an option if drilling needs to be performed on larger depths and can be used in DP mode in up to 3000 m of depth [Saipem S.p.A., 2013]. The Goliat field consists of production from reservoirs in formations Realgrunnen and Kobbe and is located at a depth of 320 to 420 m, making it possible to use both mooring and DP during drilling activities for Scarabeo 8 [Paulsen et al., 2012]. DP will also be used in the operational phase of the Goliat FPSO, a Sevan 1000 FPSO with cylindrical hull, during offloading to shuttle tankers. The requirements for distance between the FPSO and the shuttle tankers are set to 250 m as normal operating distance while the minimum distance is set to 150 m, and the shuttle tankers are required to have dedicated DP and simulator training of personnel [Tangvold, 2010].

## 2.6 Dynamic Positioning Operator

This section will elaborate about the DPO, but it is delimited to be towards the tasks during drilling operation and especially during LOP. If there is further interest in the tasks involved for a DPO, the standard “DNVGL-ST-0023:2014-04 Competence of dynamic positioning operators” can be recommended.

### 2.6.1 Barrier element during LOP incidents

During LOP incidents the DPO is involved in the recovery phase, where they can either be forced to take over the DP system or choose to do it. Commonly choosing to take over the DP system is due to uncertainties or because of lack of knowledge of how it will act in certain situations, while the DPO is forced to take over if the DP system is not operational [Sorensen et al., 2014]. In a study performed by Sorensen et al. [2014], 17 of 24 critical incidents where the DPO was involved were cases where the DPO chose to take control over the system, while the remaining 7 were forced.

The DPO has the important job of being a barrier from when the MODU loses position, which is the yellow limit, throughout the chain of events until an EQD is completed. This is illustrated in Figure 2.9, where the DPO as a barrier element in different phases of a drift-off or drive-off event is pointed

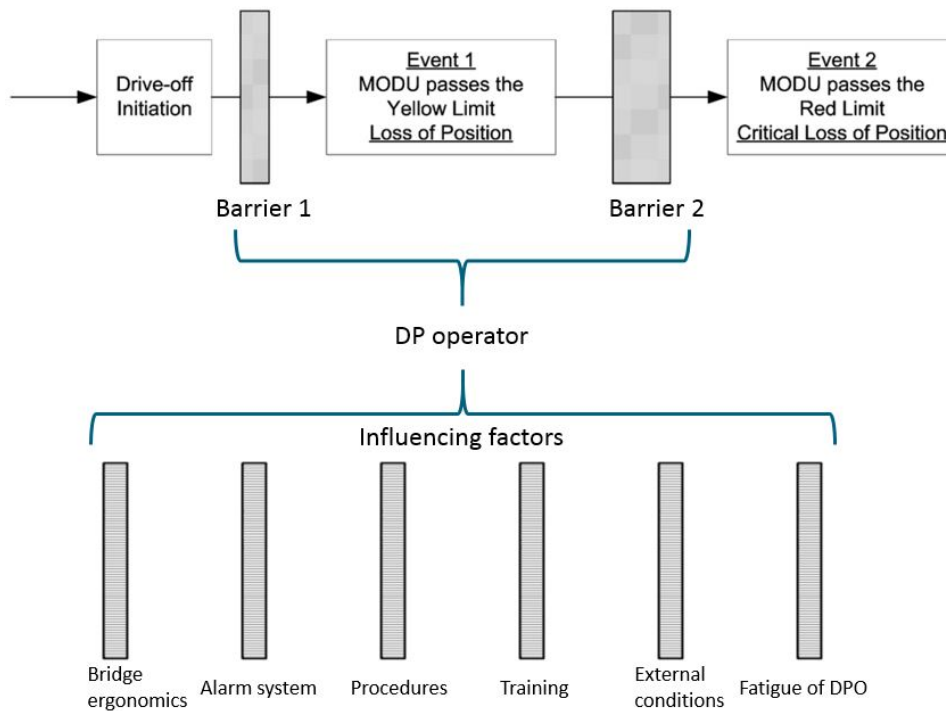

Figure 2.9: Illustration of the DPO as a barrier element, modified by Figure 8 in [Chen et al., 2008].

out along with the influencing factors on the DPO. The figure is modified from Figure 8 in Chen et al. [2008], but there are added two more influence factors; external conditions and fatigue of DPO, as they are important for the matter of this thesis.

At the yellow limit, the DPO will have to prepare for an EQD in case it drifts further away from its intended position and reaches the red limit. Within the distance between the yellow and red limit the DPO has a limited amount of time where critical decisions and tasks concerning EQD needs to be done. The time available for the DPO to complete the preparations for an EQD is determined by the speed of the MODU and distance between the yellow and red limit. Typically drive-off will give less time for the DPO as the MODU will commonly possess higher velocity in these cases than during drift-off. An EQD is not supposed to be enabled before the MODU reaches the red limit as it still has the possibility of retrieving a preferred position. For instance, during drift-off where there is loss of thruster power, one may still recover thruster power and avoid EQD. If the DPO does not keep calm during such an incident an EQD may be activated unnecessarily. But if the DPO fears an unnecessary EQD and therefore decides not to actuate it when the red limit is reached, undesirable consequences may strike when

the MODU reaches the physical limit.

It is possible to find the reliability of a DPO by reviewing each of the tasks included in the work specification for the DPO. For instance, consider a situation where LOP occurs and the DPO should activate EQD. It is possible to break down the EQD activation process down to a set of tasks and decisions which will need to be performed in numerous ways, but it is here chosen to use five main steps the DPO will need to overcome to succeed. The steps are as follows:

1. Detects LOP.
2. Decides to prepare for EQD.
3. Decision to prepare is in time.
4. EQD procedures are followed correctly.
5. DPO completes EQD procedure and activates it.

These steps will be used for the analysis in this thesis and will also be further discussed in Chapter 3.2 about human reliability.

Related to the three barrier functions associated with safety of DP drilling mentioned previously, the DPO will be an element in barrier function 3. The role of the DPO is to be a part of preventing loss of well integrity in addition to prevent from leakage of drilling mud.

### **2.6.2 Decision-making by the dynamic positioning operator**

As the DPO is a key operator for MODUs with DP and having tasks where the outcome could be of acute danger to humans, assets and environment, it is an important field of study to analyze the human decision-making under critical incidents. It is essential that the decision of activating EQD is done in sufficient time, but it is human to postpone decisions as long as possible. Postponing the decision too long risks a too late activation of EQD. A contribution to the DPO postponing the decision, and also for not initiating at all, is having second thoughts about whether initiating EQD will be the right thing to do or not. Unnecessary EQD means loss of time and will cause huge expenses, while not initiating EQD has the severe consequences already discussed.

### 2.6.3 Training and certification

As the DPO has such an important job with critical decisions on a limited time, there have been developed different training sessions and certifications to ensure sufficient knowledge and preparedness for the situations the DPO will need to conquer. Various instances, like The Nautical Institute, have developed schemes for initial training to become a certified DPO. The guideline IMCA M 117 elaborates further on formal training, experience and competence of key DP personnel. For DPOs the structure of the training course is divided into the following four phases [IMCA - The International Marine Contractors Association, 1996]:

1. DP induction course at an approved institution or on board with introduction to the functions and use of a DP system, or as a trainee DPO with on board training under supervision of an experienced DPO.
2. Documented practical experience in use of DP systems on a DP vessel for a minimum period of 30 days as trainee DPO.
3. DP simulator course at an approved training institution or on board with training in use of DP systems including simulator exercises and emergency operations.
4. Documented six months of supervised DP watchkeeping in an approved DP Logbook from the Master/OIM and previous phases have been followed and completed will result in DP certificate from an approved body.

This training course is for DPO training in general, for more about which competences a DPO will need based on type of operation it can be referred to DNV GL Standard No. 3.322 Competence of Dynamic Positioning Operators (DPO).



## Chapter 3

# Arctic Environment and Human Reliability

This chapter will describe and elaborate the most significant features related to the Arctic environment that might have an impact on offshore operations performed by humans. It will also draw similarities and dissimilarities with regards to conditions to other relevant locations where drilling operations takes place, primarily towards the North Sea and the Norwegian Sea. Some conditions are difficult to predict in advance, as weather forecasting is not adequate in the Arctic [Markeset, 2013]. A discussion on how human reliability is treated in this case and how Arctic conditions can influence the reliability of DPO will also be presented.

### 3.1 Arctic Environmental Conditions

#### 3.1.1 Cold climate

It is a well-known fact that the offshore Arctic has generally lower temperatures than most other places where drilling activities takes place. But this is not always the case as the temperature often can be considered to be at the same level as other offshore areas, as the southwestern Barents Sea can be quite similar to locations in the North Sea. The similar conditions can also be observed in Figure 2.5 where the lowest extreme temperatures in the southwestern Barents Sea seems to be quite similar when traveling straightly southwards.

In addition to the cold itself, humans operating outside will experience an excess chill effect related to wind. The National Oceanic and Atmospheric Administration (NOAA) has defined this so-called wind chill effect as “a

term used to describe what the air temperature feels like to the human skin due to the combination of cold temperatures and winds blowing on exposed skin” [National Oceanic and Atmospheric Administration, 2012]. By adding the wind chill effect to the already extreme, low temperatures experienced in the Arctic, the outcome is an effective chill of significant quantity which will give a severe change in properties of humans, materials, equipment and items [Markeset, 2013].

In the Arctic, it is proven that there are large climate differences even within the same latitude. For instance, the city of Barrow at the northern coast of Alaska and Hammerfest at the northern coast of Norway is located at about the same latitude, 71 degrees north. One would expect about the same climate at these two locations, but the fact is that the climates are highly diverse. Mainly because of the Gulf Stream, Hammerfest is considered to have a very mild climate compared to its location. In January, average temperature in Barrow is  $-27^{\circ}\text{C}$ , while in Hammerfest the temperature is  $-5^{\circ}\text{C}$ . Considering precipitation, Hammerfest has six times more rain than Barrow. There is also never sea ice in Hammerfest, while Barrow has sea ice growth along the coast during winter [Moslet, 2014].

### 3.1.2 Light conditions

During winter time there is a long period where there is limited daylight in the Arctic. Daylight is for this purpose defined as number of hours with sunlight during a day. The months where there is least daylight in the high north are December and January, where there are periods when the sun does not rise above the horizon at all. The phenomenon is called polar nights and does only exist north of the Arctic Circle or south of the Arctic Circle. At location Bear Island at about 74 degrees north the sun is away for almost three months, from November 7th to February 4th [Meteorologisk institutt, 2009].

During summertime, there is an opposite phenomenon to observe in the Arctic called the midnight sun. As the name proposes, it means that the sun is up both days and nights making it possible to do outdoor activities 24 hours a day without need for any excess lighting outdoors at night. Midnight sun occurs at the same places as for polar nights and can last for several months. For Arctic regards, the farther north, the longer the periods are with midnight sun. The maximum period with midnight sun is from the vernal equinox to autumnal equinox, while for the case of Bear Island, midnight sun lasts for about three and a half month [Pedersen, 2013].



### 3.1.3 Wind and polar lows

When assessing wind speed, statistics for years 1985-2014 are available through Norsk Oljevernforening for Operatørselskap (NOFO). The wind speeds are grouped in intervals 0-2, 2-6, 6-10, 10-14, 14-18 and wind speeds above 18 m/s and presented in percentage of time during spring, summer, autumn and winter for offshore locations Ekofisk (North Sea), Statfjord (North Sea), Heidrun (Norwegian Sea, south of the Arctic Circle) and Tromsøflaket (Norwegian Sea, north of the Arctic Circle) in Figure 3.1.

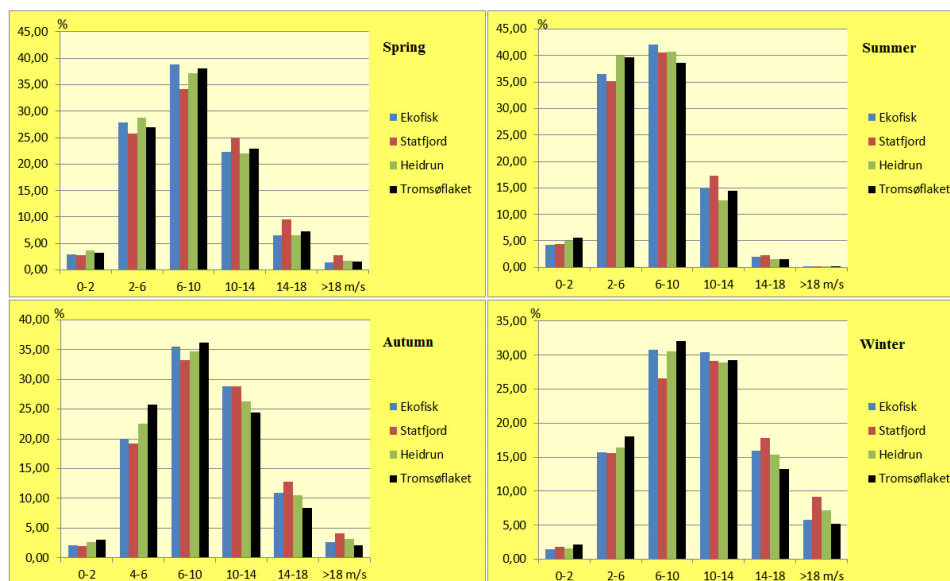

Figure 3.1: Wind speed for locations Ekofisk, Statfjord, Heidrun and Tromsøflaket during spring, summer, autumn and winter for years 1985-2014[Norsk Oljevernforening For Operatørselskap, 201Xb].

The statistics reveal that the Arctic location Tromsøflaket does not stand out significantly from the other locations within the same season in either way. It can still be remarked that there are large differences for each location when comparing seasons to each other. During summer, the amount of winds between 2 and 10 m/s count for about 75-80% of all winds, but only 42-50% during winter. For the fastest winds above 18 m/s there is hardly anyone during summer, around 2-3% in the spring, 2-4% in the autumn and 5-9% at winter time where Tromsøflaket is the lowest one, just above half of the amount at Statfjord. Also the amount of second fastest winds is greater at winter time, where they account for 13-18%, in contrast to only 1-2% for summer. The magnitude of faster winds during winter will contribute to the mentioned wind chill effect and increase this.

Polar lows are parts of wind systems commonly found in the Arctic. In the

Barents Sea they are formed by the interaction of cold Arctic air and the relatively warm sea caused by the Gulf Stream. This decreases the stability of the air and creates convective clouds. When these convective clouds meet the cold Arctic air, they interact and form vortices, or polar lows. The main characteristics of polar lows are that they can change suddenly in direction and the wind can be strong, with an average maximum wind speed of 46 knots while the highest wind speed recorded since 2000 is 70 knots [Noer, 2014]. Forecasting of polar lows is commonly poor as it is difficult to predict outcomes of the initiating event. The forecasts might indicate the occurrence of polar lows, but there are related difficulties to predict their size, location and strength [Markeset, 2013].

Wind does also possess the ability to increase impact of other conditions. It has already been proposed the effect on felt temperature by wind chill, but in addition to this there are effects related to sea state and accumulation of ice and snow, which will be up for discussion in the following sections.

#### **3.1.4 Fog and mist**

A cloud which is in contact with the ground is defined as mist if the visibility is more than 1 km and fog if it is less [Fagerlid, 2013]. In the high north these phenomena are most common in the summer, caused by hot air meeting the relatively cold Arctic ocean. This is the case for the locations Bear Island and Hopen in the Barents Sea, where there is 11-27% fog in months June-September, while there is 4-8% during the rest of the year [Tangen, 2014].

#### **3.1.5 Icing and snow**

The intensity of snowfalls vary and classification of it is usually done either by accumulation in centimeters per hour or by meters of visibility. The American Meteorology Society classifies snow by the last-mentioned, where light snowfall is when visibility is more than one kilometer, moderate for visibility between a half and one kilometer and heavy when visibility is less than half a kilometer [American Meteorological Society, 2013]. In addition to snowfalls, snow can be observed as snowstorms and drifting snow which will gather where it is prone to accumulate.

Besides snow, ice is likely to accumulate on offshore assets from both seawater and freshwater where the environment is suitable for ice growth. Ice from seawater typically occur topside from waves and sea spray. To predict accumulation of ice from seawater an algorithm by James E. Overland shows that

the icing rate is dependent on wind speed, air temperature, sea temperature and the freezing temperature of seawater [Overland, 1990]:

$$PR = \frac{V_a(T_f - T_a)}{1 + 0.4(T_w - T_f)} \quad (3.1)$$

where

**PR** Prediction

$V_a$  Wind speed (m/s)

$T_f$  Freezing point of seawater (about  $-1.7^\circ\text{C}$ )

$T_w$  Sea temperature ( $^\circ\text{C}$ )

$T_a$  Air temperature ( $^\circ\text{C}$ )

In addition to these values, other specifications like characteristics, speed and direction will determine ice growth on a vessel [Overland, 1990]. The predictor is not accurate, but tells the icing class and growth rate based on the input data. Higher prediction gives a better environment for ice to accumulate, as shown in Table 3.1.

Table 3.1: Table for prediction of ice accumulation [Overland, 1990].

	Light	Moderate	Heavy	Extreme
Icing rate (cm/hour)	<0.7	0.7-2.0	>2.0	
Predictor	<20.6	20.6-45.2	>45.2	>70.0

The freezing point of seawater does seldom vary a lot, but the other variables do. Note that lower air and sea temperature and higher wind speed will give a higher prediction. This means that Arctic offshore environment consisting of both extreme low air and sea temperatures along with heavy wind makes a good environment for ice accumulation by seawater. The sea temperature in the Arctic is variable, where the mean monthly sea temperature value calculated from 1972 at Bear Island ranges from  $-1.6^\circ\text{C}$  in February to  $3.8^\circ\text{C}$  in August according to statistics from met.no. The mean value in March is said to be  $-1.5^\circ\text{C}$ . Keeping this value constant will provide the ice predictor nomogram in Figure 3.2 when taking input values of wind speed and air temperature [National Oceanic and Atmospheric Administration, 2005].

Icing may also appear from freshwater, which is likely to accumulate from precipitation, water leakages, condensed water vapor, etc. A difference between ice from seawater and freshwater is that due to the higher freezing point of freshwater, the ice growth will be faster than for seawater at the

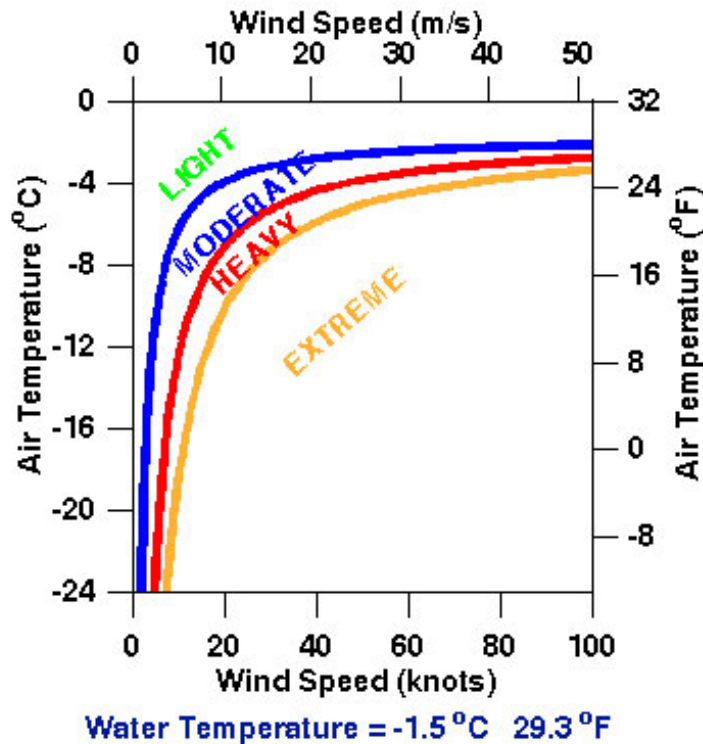

Figure 3.2: Ice predictor nomogram for a constant sea temperature of  $-1.5^{\circ}\text{C}$  [National Oceanic and Atmospheric Administration, 2005].

same environmental conditions. This implies that the Arctic conditions will give good growth conditions also for freshwater ice. In addition to accumulating ice on assets, ice may be present drifting in the sea in forms like icebergs, which leads to additional risk for operations in the Arctic.

### 3.1.6 Sea state

It is a common assumption to believe that waves are higher in the Arctic than in other locations. The statistics in Figure 3.3 proves that this cannot be considered as unison, at least not for all parts of Arctic.

Tromsøflaket in the southwestern Barents Sea is not significant in either way with regards to wave height compared to the other locations in the comparison. Heidrun and Statfjord proves to be the locations with the highest amount of waves with height 3-4 m and above 4 m, while Ekofisk on the

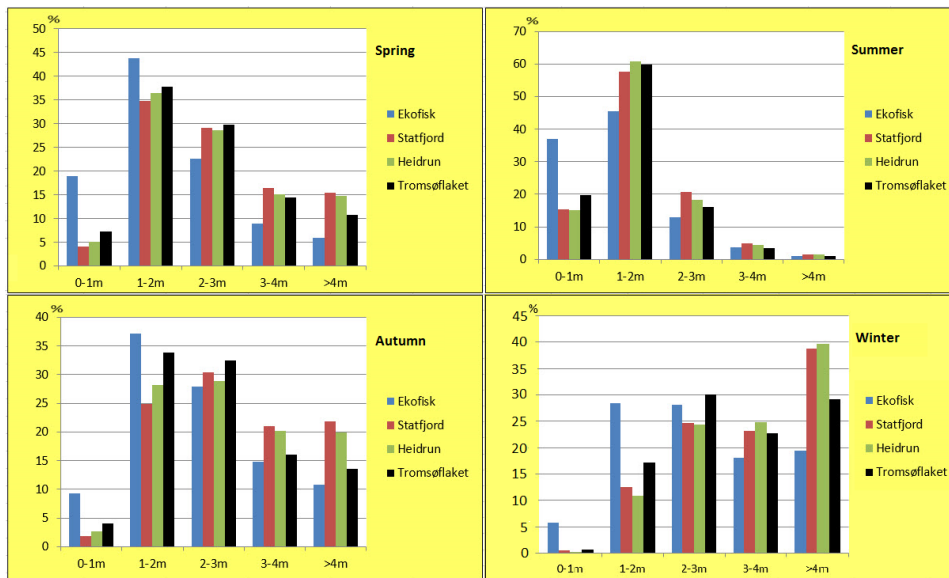

Figure 3.3: Significant wave height for locations Ekofisk, Statfjord, Heidrun and Tromsøflaket during spring, summer, autumn and winter for years 1985-2014 [Norsk Oljevernforening For Operatørselskap, 201Xa].

other hand seems to be the place with calmest sea state of the four. The observations for Tromsøflaket are in between these statistics for almost all wave heights and seasons. Interesting also here is the difference from season to season. While spring and autumn statistics are quite the same, the difference is huge between summer and winter. The amount of waves with height 3-4 m and above 4 m is considerably larger during winter, accounting for about 37-65%, while there is below 10% for each location at summer. The sea state is therefore in general calmer in the summer, having wave heights from 0-2 m from 73 to a little over 80% of the time, and only 11-34% in the winter. Wave height and state of the sea do also correlate to wind speed, which is shown in Appendix A.1. A more significant wave height combined with the high wind speeds during winter will give an unfortunate effect on offshore installations, making them more prone to ice accumulation.

### 3.1.7 Mental stress factors

Working offshore on a facility in the Arctic can, in addition to the physical effects mentioned, have large impacts on the mental state of workers. During polar nights, when there is no daylight and everything to see outside is the dark ocean and the facility itself, mental stress can be induced. Drowsy and tired workers are also common due to sleeping problems. The sleeping

problem is partly induced by too small differences in the melatonin level of the body. Melatonin is a sleeping hormone that is secreted when eyes detect darkness and the secretion decreases when eyes sense light again. During summertime in the Arctic when there is midnight sun there are small variations in light settings, making the secretion of melatonin more even through days and nights. These small differences in melatonin levels makes it problematic for the body to sense when it should be tired and will reduce quality of sleep [Øvreberg, 2012]. In the summertime, there are various effects of midnight sun experienced. Some people experience additional energy from their increased time exposed to daylight, while others experience sleep disturbances because of keeping strange hours as the sun is up all the time.

The distance from facilities located around Bear Island to sufficient infrastructure for transporting personnel is significant, and if the personnel yet again needs to travel from another location, it will require considerable travel time.

## 3.2 Human Reliability

### 3.2.1 Human reliability as a series system

Reliability of human operators can be viewed in numerous ways, but it is here treated likewise as reliability of processes and can hence be expressed mathematically by a series system made up of probabilities of performing each action in the right manner [Sondalini, 2009]. To calculate this, one will need the probability for each of the tasks in the job process being performed correctly. An illustration of how the tasks relate and depend on each other in the job process is presented schematically in Figure 3.4.

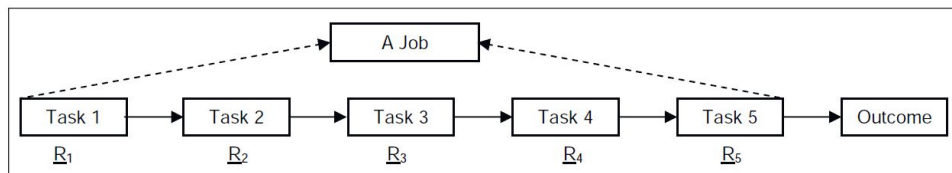

Figure 3.4: Series of tasks in a work process set in system [Sondalini, 2009].

It can be observed that each task is dependent on the previous one, so all of the tasks need to be performed to be able to reach the outcome. Calculating the reliability for this job, which is the probability of it being performed correctly, can be expressed in mathematical terms like in Equation 3.2.

$$R_{job} = \prod_{i=1}^n R_i = R_1 \times R_2 \times R_3 \times R_4 \times R_5 [\text{Sondalini, 2009}] \quad (3.2)$$

The probability of correctly executed job is here denoted  $R_{job}$  and is found by multiplying the reliability of each of the tasks. The probability for the job being performed right is never higher than the lowest individual task probability [Sondalini, 2009]. This sort of view on human reliability is possible to apply where there are such series of steps which needs to be performed, which is often the case for routine work. The reliability for each task,  $R_i$ , can be addressed by reviewing the error rate, ER, for each task like expressed in Equation 3.3.

$$R_i = 1 - ER_i \quad (3.3)$$

There will be different conditions influencing each of the tasks. Important conditions are training and experience of the worker, mental state, complexity of the task, and the environmental conditions which the task needs to be performed under. An analysis of how these effects can influence each of the tasks in a routine job will be presented in 5.1.2.

### 3.3 Arctic Impacts on Human Reliability

When considering the factors described previously in this chapter, the overall maintainability and reliability of humans working under such conditions will certainly decrease. Operations, equipment, tools, working environment and items where operation or maintenance is to be performed will all have to be reviewed carefully when making procedures, guidelines and job orders. This part of the report will analyze more in detail how these mechanisms can have an influence on maintainability and reliability of human workers.

#### 3.3.1 Freezing, mobility and motoric precision

First of all, human beings working outside in cold climate will need to protect themselves of freezing and frostbite. Cold itself along with the wind chill effect makes the environment related to temperature tougher than most places. For human beings, the accuracy and response when working with cold hands is highly reduced. Fingers are moving slowly, the grip is worse, and the motoric precision is less than when working in temperatures that are more suitable for humans. There are several opportunities to protect a worker from cold temperatures and wind; shelter, heating of working area

and dressing up the worker are common solutions. But on offshore installations shelter and heating is commonly not practically possible due to lack of space or cost of implementing versus the yield. This means that the worker will have to dress up in bulky, windproof clothes. To properly handle tools, equipment and items, especially small gears like screws and bolts, is a challenge with heavy clothing, safety boots, gloves or mittens. An operator who is supposed to handle a remote with small buttons and joysticks while wearing mittens will have difficulties maneuvering it accurately. This means that the cold will obviously have an undesirable influence on both maintainability and reliability of working humans. Furthermore, working physically when heavily dressed up can cause a worker to sweat because of increasing body temperature combined with lack of sufficient ventilation. When the physical work is paused, the soaked clothes will pull energy out of the worker to become dry again. This energy is the body heat of the worker, which causes the worker to freeze and can further on lead to a cold and pneumonia.

### 3.3.2 Balance

If ice, which has very low friction, accumulate on floors, steps, or other surfaces, it can cause balance problems and/or unfortunate working position when trying to compensate for it. Heavy clothing gives less supple movements, so use of heavy clothing while carrying or handling equipment when slipping on ice makes it a challenge trying to regain the balance. Polar lows and regular winds will also have an impact on balance as it is a force working directly on the body. When wearing bulky clothes, the vertical area of workers is larger, making them more susceptible for wind. Waves acting on the installation will also cause unstable working conditions.

### 3.3.3 Equipment and tools

Icing on equipment, tools and items can cause large difficulties trying to handle them properly. If it accumulates on places from which it cannot be removed, it will make the item heavier, slipperier and maybe also impossible to handle. Ice does typically have a smooth and slippery surface, so a tool where the grip is covered by ice can cause huge problems for a worker to handle the tool. Handling tools in heavy clothing is also considered to be a huge problem. Professor Tore Markeset at the University of Stavanger draws a parallel between this and a relatively easy assignment like changing tires in cold, snowy and dark conditions when describing what one can expect from performing more delicate tasks in the Arctic offshore environment [Okstad, 2012].



### 3.3.4 Vision impacts

To work in darkness during polar nights instead of optimal light conditions does certainly have undesirable effects on the reliability of a worker. Some places are difficult to give proper illumination by lamps, headlights or flashlights, which makes it problematic to execute operations in the right manner. This will give a reduction in the quality of work performed and hence the reliability of the worker. However, when assessing light conditions only, working nighttime outside in the summer is quite the same as working daytime due to the midnight sun. With the sun still illuminating the sky during nighttime the light conditions are fairly similar to daytime, which makes it a better basis for performing operations and maintenance actions at night in the summer than locations without midnight sun. Snow and fog along with wearing hardhats and protective goggles will also impair the visibility by reducing the visibility range. For the snow case, it does not only in itself weaken the visibility, but if a worker is wearing headlights in snowy weather there is the possibility of experiencing reflected glare from the headlights, which can also be observed when using headlights while driving a car under dark, snowy conditions. In addition to snow, ice, frost and dew may accumulate on windows and goggles, causing reduced visual perception, disorientation and possibly dangerous situations.

### 3.3.5 Mental and physical condition

When performing work offshore in the Arctic, there is a possibility that the work is not done properly due to the mental state of a worker. The worker can be tired of sleeping troubles related to polar nights or midnight sun or just mentally exhausted by all the impressions and physical and mental challenges exposed to throughout the working period. A rolling vessel can lead to seasickness and feeling groggy, which might have unfortunate results on tasks, especially those who need extra mental attention, like key operators often need in their work. When off work, quality of rest is highly influenced by these factors and will then influence the workers quality of work.

### 3.3.6 Confined working space

Drifting snow and ice can accumulate in areas where operations and maintenance activities are supposed to take place and occupy a lot of space. It may be difficult and time consuming to get rid of it. Also, trying to shelter areas from wind, precipitation and cold can reduce the space needed for getting sufficient elbow room.

### 3.4 Reliability of the Dynamic Positioning Operator Under Arctic Conditions

The work place of the DPO is on the bridge located inside the MODU which means that the DPO is sheltered from most of the direct physical impact of the Arctic conditions expounded. It then eliminates the need for heavy clothing while working with important tasks.

However, the vision may be impaired by darkness, fog and snow in addition to the fact that windows might be covered by ice, frost and dew, narrowing the field of view. Physically, the DPO can suffer from tiredness and sleepiness from insufficient rest or sleep disturbances on top of seasickness. Handling difficulties of the MODU might also be induced by harsh weather conditions and lack of experience in such conditions, and the DP system can be affected by icing on position reference sensors, auroras, etc. How these factors work to decrease the reliability of the DPO, causing DPO error, will be illustrated in the results section.

As already mentioned in 2.6.1, the reliability of the DPO can be determined by reviewing each of the tasks in the job description. This will need the probability for performing each of the tasks correctly. A more comprehensive examination of the reliability of the DPO can be achieved by further dividing each of the tasks into subtasks and then into basic steps at the lowest level which seems to be practical. Another advantage with dividing into subtasks and basic steps is that by including these in the job description, it will provide a more detailed guidance for the DPO and hence increase the focus and the reliability of the job in total.

The basis for determining the reliability of the DPO under influence of Arctic conditions will be provided by increasing the expected error rate of the DPO for each task. This will decrease the overall reliability for the Arctic case, which will be shown in 5.1.2.

## Chapter 4

# Quantitative Risk Assessment

### 4.1 Introduction to QRA

A risk assessment is said to cover the processes risk analysis and risk evaluation as illustrated by Figure 4.1, a figure adapted from Aven [2011].

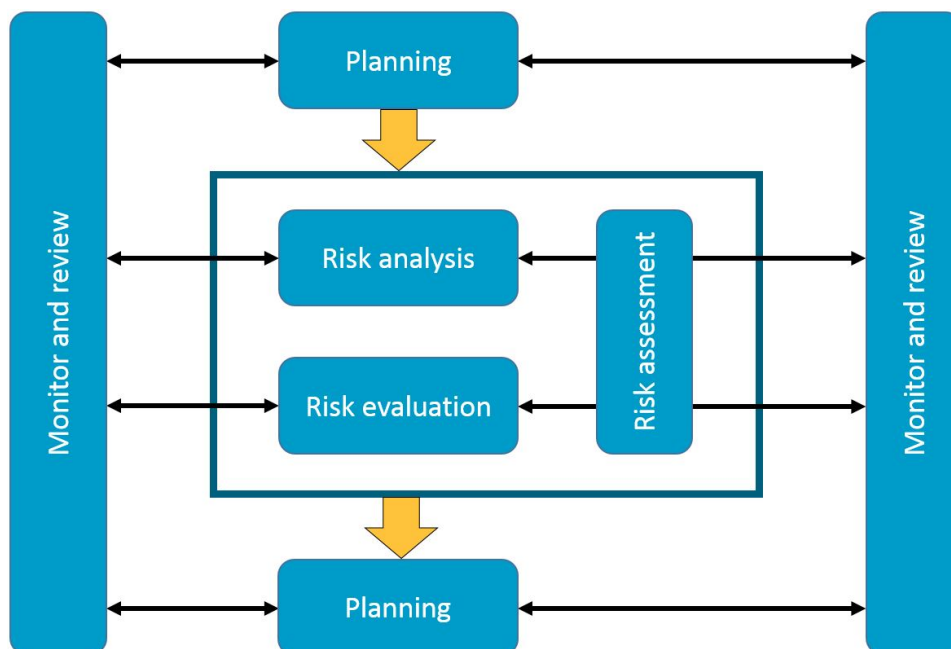

Figure 4.1: The risk assessment process as described by Aven [2011].

Compared to a qualitative risk assessment, a quantitative risk assessment

assigns a numeric value to the related risks so they can be assessed, compared and give a basis for whether an action should be performed to reduce the risk or not. The QRA can also prioritize and tell the order of how the risk reduction measures should be performed to reduce the most significant risks first. Quantification is given in the matter that is most suitable, commonly cost, FAR rate, PLL, RIN, etc., and can further on be allocated to a risk matrix for classification of the risk [Aven et al., 2010].

Furthermore, the main steps in a risk assessment process are commonly applicable for every type of risk assessment. Aven [2011] has identified four main steps a risk assessment should comprise:

1. Hazard identification
2. Cause analysis with hazard frequency analysis
3. Consequence analysis
4. Risk picture

In this chapter several QRA methods will be discussed, and each of them can be assigned to these steps. It will also be explained how each technique will be applied in this assessment, as there are several methods to utilize the techniques.

## 4.2 Use of QRA

### 4.2.1 Risk management and decision-making

For risk managements, a correctly and thoroughly performed QRA based on a comprehensive data set is a very valuable tool used for decision-making, as it will produce a numerical value for the management to relate to [Aven et al., 2010]. If a classification of the risk is demanded to see how the individual risks relate to each other, it is effortless to introduce a risk matrix and determine values for each group of risks which will give a more illustrative risk picture.

A QRA can be used in various ways, like calculating annual expected cost of an initiating event based on the probabilities and costs of the different outcomes. It can also tell whether risk-reducing measures need to be implemented or not and tell the order of how the measures should be executed in order to reduce the most significant risks first or make the least expensive risk-reducing measure.

### 4.2.2 Describing risk quantitatively

Risk can be described quantitatively in several means, but it is important to select the quantification measure that will be most practical to relate to. Some of the common description terms for risk are Aven et al. [2010]:

- PLL = Expected number of casualties for one year
- FAR =  $\frac{PLL}{nt}10^8$ , expected number of casualties per 100 million hours of exposure. n = number of persons exposed and t = hours of exposure.
- IR = Probability of an individual to perish during a given period of time.
- Risk matrix = Categorization av possible consequences and related probability, as described in 4.3.5.

The term for describing risk used in this thesis is by use of a risk matrix to give an illustrative overview of how the risks relate to each other.

## 4.3 Relevant QRA Techniques

### 4.3.1 Event tree analysis

Event tree analysis is a multifunctional analysis, examining how an initiating event can develop over time through a set of branches and can be used both quantitatively and qualitatively. An ETA is executed by asking questions for each step where the answer is either “Yes” or “No”, where it is common to let one of the answers be the least wanted one for all branches for getting a better overview of the situation. When asking the questions for each branch, there are two basic strategies; either to base the questions on events which might happen, like fire or explosion, or in the barrier elements [Aven et al., 2010].

For the matter of this thesis it will be used as a qualitative consequence analysis as well as for quantifying the frequencies of the respected consequences by analyze of how an LOP event of a MODU might evolve. This is achieved by analysis a set of influencing factors and barrier elements relevant for the situation, and analyzing how different pathways will give different outcomes and probabilities. This means that the question strategy is a combination of those mentioned. The questions will also be asked in a manner that the answer “No” is the preferred outcome.

### 4.3.2 HAZID

As mentioned in 4.1, the first step of a risk assessment is hazard identification. This can be achieved by performing a HAZID analysis which is said to be “the process of identifying hazards, which forms the essential first step of a risk assessment” [Germanischer Lloyd, 2008]. A HAZID worksheet can be designed in multiple ways, the design should be fitted to the purpose. A HAZID is considered as a critical analysis technique as it settles what types of hazards the risk management has to deal with. If a hazard is not identified, it can not be dealt with [Aven, 2011]. Performing a HAZID should include specialists on the field of study with a wide range of backgrounds and expert knowledge concerning the subject in focus. This is to achieve a more comprehensive HAZID analysis with different point of views and reduce the probability for a hazard not being assessed.

The HAZID used in this analysis is a HAZID worksheet similar to the one found in Section 3.2 in DNV GL [2013], but there are also added consequence classifications for personnel, assets and the environment, with rankings from 0 to 5, where 5 is the most severe consequence. The events analyzed are the main end events gathered from the outcomes of the ETA. The sub-events are considered to have the same consequence classification as the main events.

### 4.3.3 Fault tree analysis

A fault tree analysis (FTA) is considered as a method used in step two of the risk assessment process, as it analyzes the possible causes that lead to the unwanted top event. It can be used to analyze qualitatively how failure of barriers and which combination of these that will result in the top event. By adding frequencies or probabilities to each of the gates one will also get the basis for a hazard frequency analysis, which is quantitative. The most common gates and symbols in FTA are shown in Figure 4.2 and they are used as follows [Aven et al., 2010]:

- **OR-gate:** The event will happen if at least one of the events below occur.
- **AND-gate:** The event will happen only if ALL of the events below are occurring at the same time.
- **Event explanation:** Box placed on top of logic gates to explain the event in consideration.
- **Basic event:** Event at the lowest level for the matter of the analysis.



Figure 4.2: The most common gates and symbols used for FTA analysis; OR-gate, AND-gate, box for description of event and basic event.

The FTA in this thesis will be used only qualitatively and concern how different Arctic environmental factors can influence the reliability of the DPO, inducing DPO error.

#### 4.3.4 Risk acceptance criteria

Risk acceptance criteria are set for each different operation taken into account. By regulations, authorities may set their risk acceptance criteria for an operation to be allowed to be executed. Areas with very vulnerable environments, like where large scale spawning of cod takes place, will demand higher safety of oil and gas operations to protect the environment. Risk acceptance criteria can also be defined by risk managements and company policies. If the risk is below a predetermined value, it is acceptable, and if not, risk reduction measures needs to be initiated. If the risk is considered to be tolerable, the principle of ALARP (As Low As Reasonably Practicable) should be introduced to lower the risk further. ALARP means that the yield of risk-reduction measures should be in reasonable relation to the cost of implementing the measures [Aven et al., 2010]. The criteria are set by the type of quantification of risk which is most practicable.

In the analysis section the risk acceptance criteria are divided into three levels; intolerable, tolerable and acceptable. They are presented in a risk matrix where different areas are different levels of risk. Intolerable risk is in the red zone, tolerable risk is colored yellow, and acceptable risk area is colored green.

#### 4.3.5 Risk matrix

A risk matrix takes the probability and consequence of an event as input to position the event with regards to risk. It is therefore a prerequisite that these must be known to have the possibility to carry out the risk matrix.

The predetermined risk acceptance criteria will define which probabilities and consequences which will be acceptable, and hence describe which parts of the risk matrix which are acceptable, tolerable and intolerable. The consequences and probabilities for each event is used in risk matrices in the same manner as plotting coordinates in a map to classify their risk. However, it might be difficult to separate two events who are somewhat similar as the risk matrix is separated into rather rough categories, where a logarithmic scale is commonly used [Aven et al., 2010]. Figure 4.3 shows a risk matrix used by DNV GL.

PoF Ranking	PoF Description	A	B	C	D	E
5	(1) In a small population, one or more failures can be expected annually. (2) Failure has occurred several times a year in the location.	YELLOW	RED	RED	RED	RED
4	(1) In a large population, one or more failures can be expected annually. (2) Failure has occurred several times a year in operating company.	YELLOW	YELLOW	RED	RED	RED
3	(1) Several failures may occur during the life of the installation for a system comprising a small number of components. (2) Failure has occurred in the operating company.	GREEN	YELLOW	YELLOW	RED	RED
2	(1) Several failures may occur during the life of the installation for a system comprising a large number of components. (2) Failure has occurred in industry.	GREEN	GREEN	YELLOW	YELLOW	RED
1	(1) Several failures may occur during the life of the installation for a system comprising a large number of components. (2) Failure has occurred in industry.	GREEN	GREEN	GREEN	YELLOW	YELLOW
CoF Types	<b>Safety</b>	No Injury	Minor Injury Absence < 2 days	Major Injury Absence > 2 days	Single Fatality	Multiple Fatalities
	<b>Environment</b>	No pollution	Minor local effect. Can be cleaned up easily.	Significant local effect. Will take more than 1 man week to remove.	Pollution has significant effect upon the surrounding ecosystem (e.g. population of birds or fish).	Pollution that can cause massive and irreparable damage to ecosystem.
	<b>Business</b>	No downtime or asset damage	< € 10.000 damage or downtime < one shift	< € 100.000 damage or downtime < 4 shifts	< € 1.000.000 damage or downtime < one month	< € 10.000.000 damage or downtime one year
<b>CoF Ranking</b>		<b>A</b>	<b>B</b>	<b>C</b>	<b>D</b>	<b>E</b>

Figure 4.3: Example risk matrix gathered from DNV GL [2010b].

The position that the events get will tell whether their risk is acceptable or not. In Figure 4.3 the red zone illustrates unacceptably high risk, while yellow and green zones both represent acceptable risk, where yellow zone is medium and green is low risk [DNV GL, 2010b].

The risk matrix in the analysis will get input data for probability from the ETA and for consequences from the HAZID. The data will be further ranked to be classified within five groups of both probabilities and consequences. There will be presented three risk matrices, one for the individual end events



in the Arctic, one for the individual end events for the general case and a risk matrix which compares the main events topside blowout, subsea blowout and no hydrocarbon release for the two cases.



## Chapter 5

# Results and Discussion

### 5.1 Results of the Study

Based on the features of the Arctic environment, the DP system and DPO discussed in this thesis, certain QRA techniques proved to be applicable for analyzing risk during LOP incidents. The survey on how the operation is affected by Arctic conditions in terms of risk will be presented in a risk matrix for the end events of LOP incidents, based on the consequences and calculated probabilities. Hence, the following techniques are used to achieve the basis for determining risk during LOP incidents.

#### 5.1.1 Fault tree analysis

Based on the findings in Section 3.4, the FTA in Figure 5.1 is developed to qualitatively analyze possible mechanisms which will influence the DPO to not perform. The top event is labeled “DPO error”, where influence can be either mental, physical or related to system failure. The influence factors are divided into “Handling difficulties”, “Vision impacts”, “Lack of concentration”, and “System failure”, where the latter three are considered to be those most prone to be affected by Arctic conditions. There is also added a basic event meant to cover other factors than those presented by the other basic events. The basic events are marked with numbers 1 to 15, with further explanation in the legend.

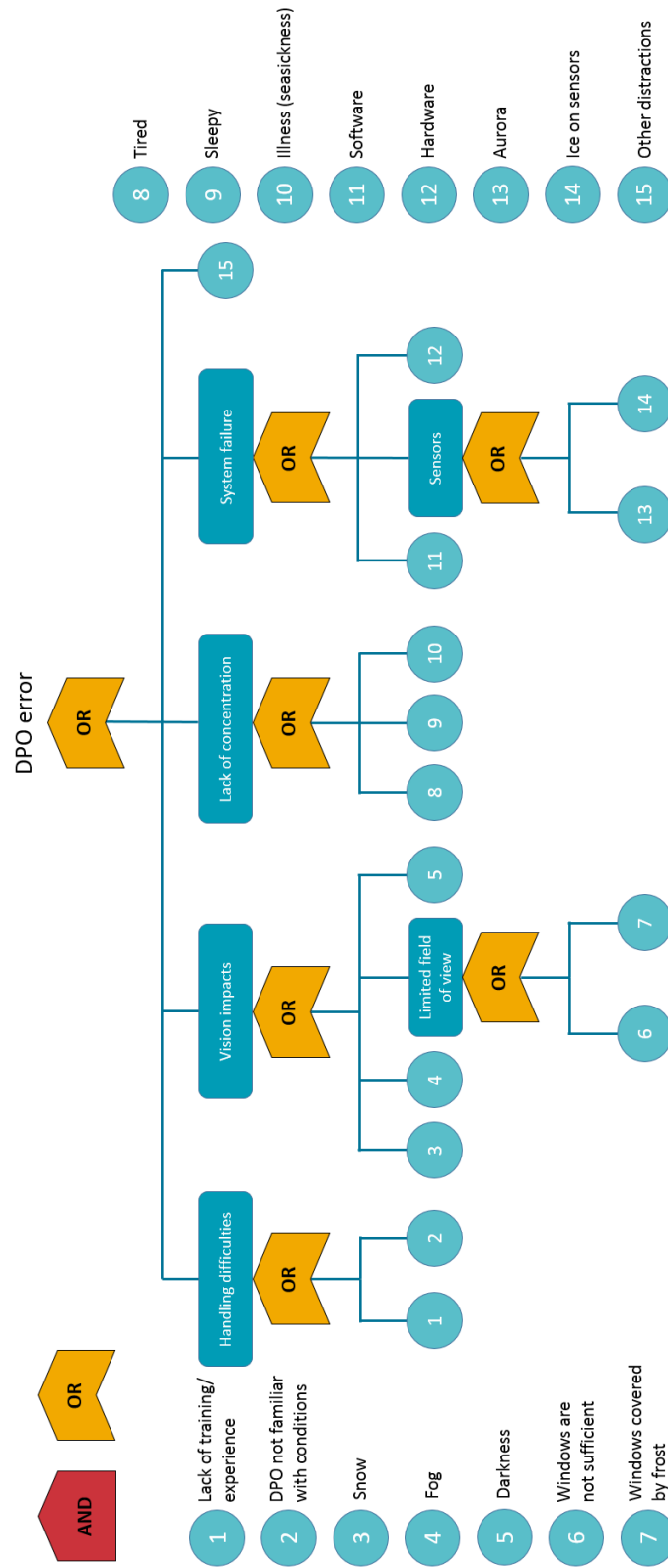

Figure 5.1: Fault tree for the top event “DPO error” by impact of Arctic conditions.

Note that there are no AND-gates in the FTA, which means that there is no need for more than one of the basic events to initiate occurrence of the the top event. Several of the basic events related to the physical environment are more likely to be found in the Arctic than other places, like aurora, snow, and darkness, but it is noteworthy that also the mental state of operators in the Arctic can be affected. For instance, tiredness and sleepiness can be a consequence of polar nights, long travel distances and sleep disturbances from noise, etc. The current basic events could have been derived further into these secondary causes, but it was chosen not to pursue that in this FTA.

It should from the FTA and the interpretation of it be clear that the factors contributing to DPO error are larger both in qualitative and quantitative measures in the Arctic than e.g. the North Sea. The failure rate of DPO errors is thus expected to increase, something which will have adverse effects on how likely a DPO is to perform the tasks during an EQD in the right manner. The result of this will be further presented in the next part.

### 5.1.2 Reliability block diagram

It is suggested in Section 3.2 that analyzing human reliability can be treated as a series system, just like a reliability block diagram (RBD). Here, the RBD consists of the main steps for a DPO in an EQD sequence where the probability of each of them being performed correctly is assigned. By multiplication of each of the reliabilities of the steps the total probability for the sequence, named “EQD successfully activated by DPO”, is achieved. There are two RBDs presented in Figure 5.2 and Figure 5.3, one for a general case and one for an Arctic case.

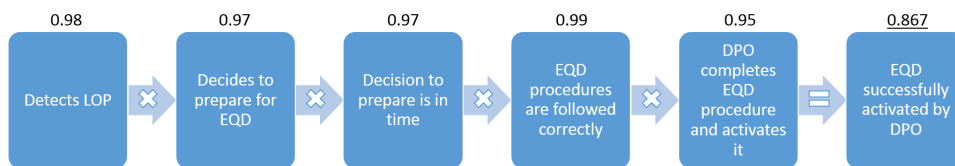

Figure 5.2: RBD for the steps to find the probability of the DPO successfully actuating EQD for the general case.

Qualitatively, the steps are similar for both Arctic and general case, it is quantitatively that the differences are located. For the general one, there is one reliability for each of the steps, ranging from 0.95 to 0.99, resulting in successful activation of EQD by the DPO to have a probability of 0.867.

For the case where Arctic conditions are considered the same probabilities as

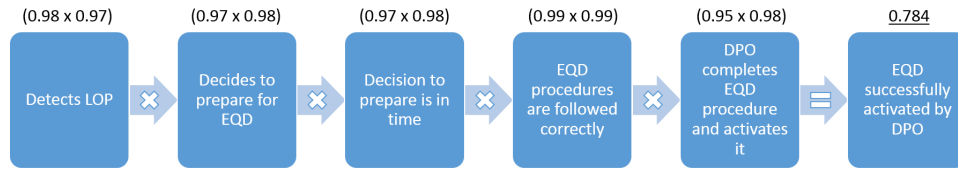

Figure 5.3: RBD for the steps to find the probability of the DPO successfully actuating EQD for the Arctic case.

for the general case are used, but there is also added a secondary probability for each step. This probability represents that the probability for each of the steps being performed correctly is lower due to the impact from Arctic conditions than in the general case, which was obtained in the FTA. The lower value the secondary probability is assigned, the more the step is prone to be performed wrong by the DPO because of affection of Arctic conditions. The secondary probabilities range from 0.97 to 0.99, which means that the reliability of the DPO performing each step correctly will be a bit lower in this case. The overall probability that the DPO successfully activates EQD in the Arctic case is here calculated to be 0.784, as expected a lower value than for the general case.

The lowest overall probability for one step is located in the last step for both cases, “DPO completes EQD procedure and activates it”. This is because the DPO might have second thoughts regarding whether an EQD is necessary to initiate or not, due to the large expenses related to unnecessary initiation of EQD. The DPO might be worried that an investigation following the EQD can reveal that EQD was not supposed to be performed and the company will suffer economic losses from this.

### 5.1.3 Event tree analysis

The two ETAs in Figure 5.4 and Figure 5.5 to be introduced are derived from a fundamental ETA DNV GL uses for determining hydrocarbon spillage during LOP events. The modifications for the ETAs in this thesis are made by adding two more branches to it; whether the MODU will recover or not and the probability of the DPO to successfully actuate the EQD, in addition to the possibility for spillage of drilling mud during LOP.

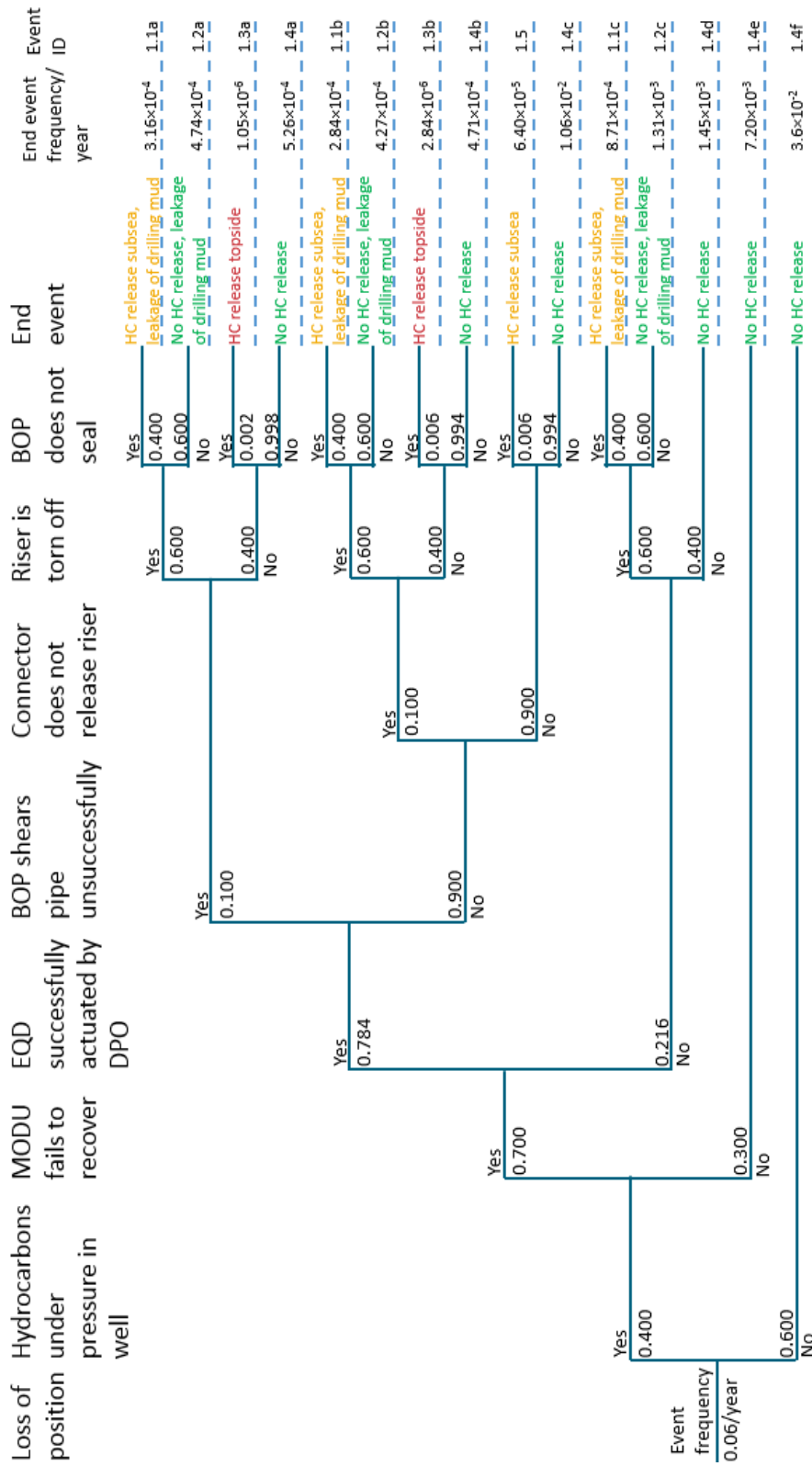

Figure 5.4: ETA for the initiating event LOP for the Arctic case.

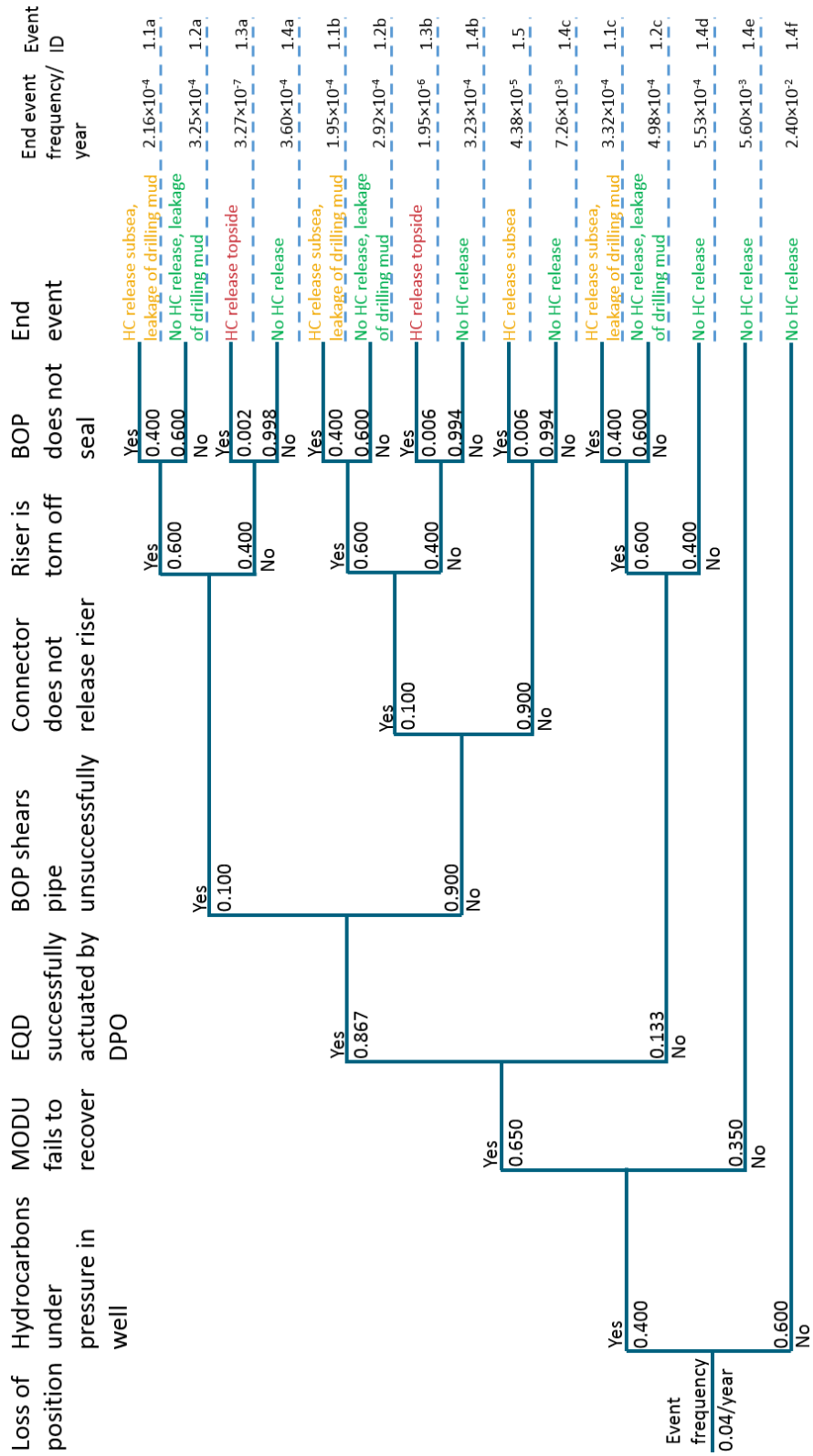

Figure 5.5: ETA for the initiating event LOP for the general case.



The LOP incidents cover both drive-off and drift-off, there are not made any differences between these two, and the probabilities used are hence hybrids of probabilities typically used for drive-off and drift-off. Normally these events are separated, as a drive-off situation will generate higher failure frequencies. This is because drive-off events often means higher vessel speed, which imply that the time needed for executing EQD is confined, and hence increase probability for the riser being torn off as well as the stress level of the DPO, which consequently will decrease the reliability of the DPO. The probabilities used in the ETAs are expected to be of quite relevant quantity based on guidance from DNV GL, where the probability for “BOP does not seal” and “Riser is torn off” are chosen to be joint for both general and Arctic case.

Like for the RBDs, the chain of events are similar for both cases and they only differ quantitatively. The ETAs are presented binary, which means that the event in the chain will either happen or not and there exists no possibility for events partly happening.

The five possible end events are qualitatively also common for both ETAs, which are given event ID's from 1.1 to 1.5. Events 1.2 and 1.4 are colored green as they are considered to be least severe. This is because for these events there are either no hydrocarbons presently under pressure in the well, the MODU recovers from the LOP state, or the BOP seals the well. This again do not result in any type of hydrocarbon spill, but only leakage of drilling mud which is the case for event 1.2, which is considered a minor pollution in this case. The yellow events 1.1 and 1.5 are considered medium in severity as there are subsea hydrocarbon spills related to these events. Common for these events to happen is that hydrocarbons needs be under pressure in the well, the MODU fails to recover, the riser is torn off or the connector releases the riser while the BOP does not seal. The case for when riser is torn off is located to event ID 1.1, where there is also associated leakage of drilling mud in the end event. This produces a slightly higher environmental consequence than for event ID 1.5. Event ID 1.3 appears two times in the ETA and is highlighted in red to illustrate the highest consequence classification for the initiating event LOP. Here, the end event is a topside hydrocarbon release which certainly causes an acute hazard to the operation overall. For this being possible, the BOP will not seal the well and the riser is not torn off, which means that there is a continuous path all the way from the well, where the hydrocarbons are under pressure, to the topside of the MODU.

The probabilities for the different events in the ETAs are common except for three of them; event frequency for “Loss of position” and event probabilities “MODU fails to recover” and “EQD successfully actuated by DPO”. The first two are different for the two cases because there are expected higher

failure rates and lower system reliability in the Arctic, and it is here demonstrated by increasing the frequency for LOP and the probability for the MODU failing to recover. The last frequency that differs is gathered from the RBD, which examined whether the DPO was likely to succeed in actuating an EQD. The result was lower reliability of the DPO for the Arctic case and the reliability is used as input here, with reliabilities 0.867 and 0.784 for the general and Arctic case respectively. The rest of the probabilities in the branches of the ETA are similar as it is assumed that the subsea systems will be rather uninfluenced by Arctic conditions.

Due to the differences in the probabilities of the three branches discussed there are also different probabilities for the end events. The most and second most probable single end events are, however, found to be the same for both cases, event IDs 1.4f and 1.4c respectively. For 1.4f there are not hydrocarbons present in the well and the probability for this is  $2.4 \times 10^{-2}$  in the general case and  $3.6 \times 10^{-2}$  for the Arctic case. 1.4c is the event where the EQD sequence goes as planned with a probability of  $7.26 \times 10^{-3}$  in the general case and  $1.06 \times 10^{-2}$  for Arctic.

By the probabilistic model for accident during DP drilling presented in Equation 2.1, all the frequencies for the end events — except for event 1.4e — will correspond to  $P(\text{accident})$ . Now, by using Equation 2.2 one may find the total probability for topside blowout, subsea blowout and events with no releases. When doing this, input values for all red events, yellow events and green events are summed up separately, and the results of these are shown in Table 5.1.

	<b>Arctic</b>	<b>General</b>
Total topside	$3.89 \times 10^{-6}$	$2.28 \times 10^{-6}$
Total subsea	$1.54 \times 10^{-3}$	$7.87 \times 10^{-4}$
No HC release	$5.84 \times 10^{-2}$	$3.92 \times 10^{-2}$
Total	0.06	0.04

Table 5.1: Comparing the probabilities for blowout in general and for the Arctic case during LOP.

Quantification of risk has previously been discussed to be presented in different terms. Here, the end events are quantified with frequency or number of events per year. These numbers form the basis for the probabilities which will be used in the risk matrix.

More specifically how these end events differ in consequence will be shown in the following HAZID, where each of them will be investigated a bit further and classified in different consequence categories.

#### 5.1.4 HAZID

The five main end events detected in the ETA needs to be examined further to establish a consequence evaluation and a sufficient overview of the risk. This is here achieved by performing a HAZID study in Table 5.2, which will determine possible causes for the event, related consequences, and what kind of safeguards, barriers and risk reducing measures that are applicable, and classify the consequences in terms of personnel, assets and environment separately for the general and Arctic case. The consequences are the same for each primary event and they are ranked from 0 to 5, where 5 is considered the most severe and 0 for when there are no related consequences, before they are averaged. The average consequence is the one which will be used for risk ranking. The basis for the consequence classifications is not justified by any particular practice, but determined through discussions. For example, one would have to know the number of present personnel and the environmental impact to be able to do this, but it is individual from operation to operation, and since this is not a specific case study it will not assess this. Instead, it is assumed that factors like rate of a spill, present personnel and other underlying factors are constant for both cases.

Table 5.2: HAZID based on the main end events 1.1-1.5 observed in the ETA.

EVENT ID	HAZARD OR CRITICAL ISSUE	CAUSE	POSSIBLE CONSEQUENCE	EXISTING SAFEGUARDS AND BARRIERS	RISK REDUCING MEASURES
1.1	HC release subsea leakage of drilling mud	BOP fails to seal while riser is torn off when physical limit is reached	- Huge environmental impact of subsea blowout - Pollution by drilling mud - Ignition of HC might lead to fire and explosion	- BOP and LMRP available and ready for EQD - Safety margin of physical limit of MODU is sufficient	Maintenance of relevant equipment follows recommended practices
1.2	No HC release, leakage of drilling mud	Riser is torn off after reaching the physical limit, but BOP seals well	Pollution by drilling mud	- Safety margin of physical limit of MODU is sufficient	Maintenance of relevant equipment follows recommended practices
1.3	HC release topside	BOP fails to seal while riser is intact	-Ignition of HC might lead to fire and explosion -Pollution by HC	BOP and LMRP available and ready for EQD	Maintenance of BOP and LMRP follows recommended practices
1.4	No HC release	- MODU recovers - HC is not under pressure in well - Riser is not torn off, but BOP seals	- Fairly harmless situation where drilling activity is paused	- DP system has high robustness of recovery - BOP available and ready if HC are under pressure	DP system and BOP is updated and maintained as recommended
1.5	HC release subsea	BOP does not seal well while connector releases riser	-Huge environmental pollution by subsea blowout - Ignition of HC might lead to fire and explosion	BOP and LMRP available and ready for EQD	Maintenance of BOP follows recommended practice

EVENT ID	CONSEQUENCE CLASSIFICATION									
	PERSONNEL		ASSETS		ENVIRONMENTAL		AVERAGE CONSEQUENCE			
	GENERAL	ARCTIC	GENERAL	ARCTIC	GENERAL	ARCTIC	GENERAL	ARCTIC	GENERAL	ARCTIC
1.1	2	3	4	4	4	5	3,33	4,00		
1.2	0	0	1	1	1	2	0,67	1,00		
1.3	5	5	5	5	5	5	5,00	5,00		
1.4	0	0	0	0	0	0	0,00	0,00		
1.5	2	3	3	3	4	4	3,00	3,33		

For all of the main events the average consequence evaluation for Arctic is either the same or higher than for the general case. There is not expected any significant difference between the two environments with regards to consequence for the assets, but there can be observed some variation for personnel and environment. The reasoning for this is that the asset is expected to be somehow similarly damaged in both cases, but the circumstances around personnel and environment in Arctic, with conditions like long distances for evacuation, darkness, cold and the vulnerable environment, makes their consequence classifications a little higher in some cases. How the main event IDs are ranked internally to each other with respect to average consequence is though the same for both cases. Topside blowout, event ID 1.3, is considered to be the worst case scenario with a ranking of 5 for all categories since it makes an acute hazard for explosions and fires in addition to the pollution itself. The runner-up hazardous event is event ID 1.1, a subsea blowout with leakage of drilling mud which is given average consequence 4 for Arctic and 3.33 for general. The consequences are qualitatively quite the same as for 1.3, but the exposure is here considered to be more direct for the topside blowout. However, a subsea blowout like in events 1.1 and 1.5 could have been assigned higher values because a subsea blowout may be more difficult to manage, especially for larger depths.

### 5.1.5 Risk matrix

Based on the frequencies gathered from the ETA and the average consequence evaluation from the HAZID, the fundamentals for input in the risk matrix are attained. The probabilities and consequences will be further ranked into five main groups to be able to use in a 5×5 risk matrix. The justifications for the ranks are shown in Table 5.3, where the probability rank is based on the standard DNV GL [2010b].

Consequence	Consequence rank	Probability	Probability rank
0-0.99	A	$< 10^{-5}$	1
1.00-1.99	B	$10^{-5} - 10^{-4}$	2
2.00-2.99	C	$10^{-4} - 10^{-3}$	3
3.00-3.99	D	$10^{-3} - 10^{-2}$	4
4.00-5.00	E	$> 10^{-2}$	5

Table 5.3: Ranking consequences and probabilities.

Now, by evaluating the probabilities from the ETAs and the average consequences from the HAZID they are to be classified by this table. This is shown in Table 5.4 for all end events both for Arctic and general case.

Table 5.4: Probability and consequence ranking for each individual event.

Event ID	Arctic			General				
	Probability	Probability ranking	Average consequence	Consequence ranking	Probability ranking	Average consequence	Consequence ranking	
1.1a	$3.16 \times 10^{-4}$	3	4.00	E	$2.16 \times 10^{-4}$	3	3.33	D
1.1b	$2.84 \times 10^{-4}$	3	4.00	E	$1.95 \times 10^{-4}$	3	3.33	D
1.1c	$8.71 \times 10^{-4}$	3	4.00	E	$3.32 \times 10^{-4}$	3	3.33	D
1.2a	$4.74 \times 10^{-4}$	3	1.00	B	$3.25 \times 10^{-4}$	3	0.67	A
1.2b	$4.27 \times 10^{-4}$	3	1.00	B	$2.92 \times 10^{-4}$	3	0.67	A
1.2c	$8.71 \times 10^{-4}$	3	1.00	B	$4.98 \times 10^{-4}$	3	0.67	A
1.3a	$1.05 \times 10^{-6}$	1	5.00	E	$7.21 \times 10^{-7}$	1	5.00	E
1.3b	$2.84 \times 10^{-6}$	1	5.00	E	$1.95 \times 10^{-6}$	1	5.00	E
1.4a	$5.26 \times 10^{-4}$	3	0.00	A	$3.60 \times 10^{-4}$	3	0.00	A
1.4b	$4.71 \times 10^{-4}$	3	0.00	A	$3.23 \times 10^{-4}$	3	0.00	A
1.4c	$1.06 \times 10^{-2}$	5	0.00	A	$7.26 \times 10^{-3}$	4	0.00	A
1.4d	$1.45 \times 10^{-3}$	4	0.00	A	$5.53 \times 10^{-4}$	3	0.00	A
1.4e	$7.20 \times 10^{-3}$	4	0.00	A	$5.60 \times 10^{-3}$	4	0.00	A
1.4f	$3.60 \times 10^{-2}$	5	0.00	A	$2.40 \times 10^{-2}$	5	0.00	A
1.5	$6.40 \times 10^{-5}$	2	3.33	D	$4.38 \times 10^{-5}$	2	3.00	D

Additionally, the end events can be classified by means of risk when grouped together in topside blowout, subsea blowout and for where there are no hydrocarbon release. The probabilities for each of these are added together, while the consequence rank is here chosen to be determined by the worst case for the event from the HAZID. Topside blowout is given the same consequence rank as for event ID 1.3, subsea blowout for event ID 1.1 and no hydrocarbon release for event ID 1.2, and this is illustrated in Table 5.5.

Table 5.5: Probability and consequence ranking for the main end events.

<b>Arctic</b>			
<b>Event</b>	<b>Probability</b>	<b>Probability ranking</b>	<b>Consequence ranking</b>
Total topside	$3.89 \times 10^{-6}$	1	E
Total subsea	$1.54 \times 10^{-3}$	4	E
No HC release	$5.84 \times 10^{-2}$	5	B
<b>General</b>			
<b>Event</b>	<b>Probability</b>	<b>Probability ranking</b>	<b>Consequence ranking</b>
Total topside	$2.28 \times 10^{-6}$	1	E
Total subsea	$7.87 \times 10^{-4}$	3	D
No HC release	$3.92 \times 10^{-2}$	5	A

Now, defining risk acceptance criteria is necessary. It is decided here that likewise for the example risk matrix in Figure 4.3, the red zone of the matrices are considered as unacceptable risk zones, yellow zones can be tolerated and green zones represent acceptable risk.

Finally, the settings for using the risk matrix are found by the rankings in Table 5.4 and 5.5. The risks may now be compared to each other, both for the individual cases and for the main events for general and the Arctic matter. First the risk matrix for the Arctic case for individual end events is presented in Figure 5.6, before the general case is shown in Figure 5.7 and then a risk matrix comparing risks for the total of red, yellow and green events for both the Arctic and the general case.

Probability ranking	A	B	C	D	E
5	1.4c 1.4f				
4	1.4d 1.4e				
3	1.4a 1.4b	1.2a 1.2c 1.2b			1.1a 1.1c 1.1b
2				1.5	
1					1.3a 1.3b
Consequence ranking	A	B	C	D	E

Figure 5.6: Risk matrix for the individual end events for the Arctic case.

Probability ranking	A	B	C	D	E
5	1.4f				
4	1.4c 1.4e				
3	1.2a 1.2c 1.4b 1.2b 1.4a 1.4d			1.1a 1.1c 1.1b	
2				1.5	
1					1.3a 1.3b
Consequence ranking	A	B	C	D	E

Figure 5.7: Risk matrix for the individual end events for the general case.



Probability ranking	A	B	C	D	E
5	No HC release (general)	No HC release (Arctic)			
4					Total subsea (Arctic)
3				Total subsea (general)	
2					
1					Total topside
Consequence ranking	A	B	C	D	E

Figure 5.8: Risk matrix for the three main end events for both Arctic and general case.

### 5.1.6 Interpretation and evaluation of results

First of all, when evaluating all of the results it is important to keep in mind that a significant part of the probabilities and qualitative reasoning used is fictional, and must not be considered as real data.

Secondly, the FTA for the top event “DPO error” is based on discussions, personal experiences and beliefs, and other sources to inspiration. The uncertainty for how much each of the basic events contribute to the top event is considered large, so it is therefore only used qualitatively.

Justifications of both the main and secondary probabilities of the RBDs are by the beliefs of the author and are not based on real-life events. The secondary probabilities are used to display that a DPO under influence of Arctic conditions will typically have more errors in the work than if the conditions were better. Why the secondary reliabilities differ come from the means of the FTA, which explains the factors that might influence the DPO.

The ETAs are as already mentioned modified by an actual ETA in use by professionals and some of the probabilities are based on their numbers. By assessing LOP incidents without making difference on drive-off and drift-off one will lose the significant specifications for each of these, like the mentioned higher probability for riser being torn off during drive-off scenarios. The joint probabilities used in the different branches does not take into account the distribution of drive-off and drift-off events, but take a value

somewhere in between what would have been realistic for those, which is a quite crude assumption. A higher probability for drive-off events could have been justified by expecting ice on position reference sensors which would cause erroneous signals. If one were to keep all of the probabilities constant for every single branch except for “EQD successfully actuated by DPO” for both the Arctic and the general case, it would have given a higher focus on the DPO. Nevertheless, it was chosen not to pursue this because it would have given less consideration about the system in total and its affection by Arctic conditions.

In Table 5.1 the probabilities for each of the three main events are presented. It can be noticed that Arctic possess higher probability for all of these events, and the probability of the events can be compared with regards to location as well. It is found that Arctic is expected to have  $\frac{3.89 \times 10^{-6}}{2.28 \times 10^{-6}} = 1.71$  topside blowouts for each expected topside blowout in the general case. Subsea blowouts is on the other hand likely to occur  $\frac{1.54 \times 10^{-3}}{7.87 \times 10^{-4}} = 1.96$  times as often in the Arctic than in the general case, and the events with no hydrocarbon release  $\frac{5.84 \times 10^{-2}}{3.92 \times 10^{-2}} = 1.49$  times as often.

The HAZID does also contain a lot of uncertainties and coarse assumptions and is not based on real data, only by judgments. It is expected a bit more hazardous consequences for accidents in the Arctic, which is reflected in the average consequences.

With regards to human errors from others than the DPO, it can be observed from the HAZID that none of the events originate from human errors directly, but for instance for the events where BOP does not seal, they can be related to insufficient installation of the BOP or improper execution of maintenance actions.

When interpreting the risk matrices for the individual events the first thing to notice is that the general case possess either the same or lower risk than the Arctic case. They both have three events located within the red zone, but they are transported one column to the left in the Arctic case. In the yellow zone Arctic has ten events, while the general case has six since the four others are moved to the green zone. Another thing to observe is that the sub-events are located within the same consequence column because they are equally evaluated in this matter by the HAZID, but they are located in different probability rows as each of them have distinct probabilities from the ETA.

The overall risk can by this alone be interpreted to be lower in the general case than in the Arctic, but is further examined in Figure 5.8 for the three main events. Here, the total topside blowout risk is in the same cell, E3, for both cases. Subsea blowout is for both cases located in the red zone, but in E4 for Arctic and D3 for the general case, so the Arctic case will still have

higher risk, despite that they are within the same zone. The event for no hydrocarbon releases is located in the red zone for Arctic in B5 and in the yellow zone in cell A5 for general. This means that, also by interpretation of the risk matrix for the main events, Arctic is considered a riskier area for DP drilling than for DP drilling in the general case.

From the point of view of risk managements, the total risks of topside blowout in the Arctic and in the general case are in this example actually tolerable, both placed in the same yellow cell, E1. For subsea blowout, none of the cases have tolerable risks, but the general case is lower than the Arctic one both in probability and consequences, which means that the risk can most likely more easily be reduced to be tolerable. The Arctic case without hydrocarbon release is one step higher ranked in consequence than the general, resulting in the Arctic case being intolerable in terms of risk and the general case being tolerable.

To sum up, risk-reducing measures is obligated to be implemented in order to reach the risk acceptance criteria for both of the cases with regards to subsea blowouts, and also for the Arctic case without hydrocarbon releases. For the topside blowout event for both cases, and the event with no hydrocarbon for the general case, the principle of ALARP should be applied, and risk-reducing measures should hence not be implemented unless they are more beneficial than the inconvenience to implement them.

## 5.2 Suggestions for Reducing Risk

As there are commonly quite shallow water depths in the Barents Sea for DP operations, the response time of a DPO has to be low to be able to perform EQD within the required time. The red limit and physical limit will approach fast as small differences in location will give a large deviation in the angle of the riser configuration. Use of auto EQD can be considered as an additional barrier element as it would enhance the probability that EQD is initiated in time. Auto EQD does not need to take into account response time or the personal judgments of the DPO, so the human errors are therefore diminished. It is now mandatory for new vessels to be equipped with auto EQD as per API 53S, and it is present on e.g. Scarabeo 8 [Al-lara, 2015]. However, if the DGPS provides incorrect position information, unnecessary EQDs might occur, leading to unwanted drilling interruptions. The cost of a single disconnection is of significant value, calculated to \$2-3 million in average. A decision by the DPO leading to initiation of an unnecessary EQD should however not be blamed on the DPO if he or she has followed the procedures as supposed to [Chen et al., 2008].

What is also important due to the shallow waters is to have accurate position

reference systems and make sure they are maintained sufficiently. Maintenance must be performed both with regards to the software system and physically to ensure sensors and signal receivers are free from snow and ice and in perfect condition to avoid erroneous input data. This because the small differences in position can give large effects in shallow waters by executing safeguarding procedures like auto EQD.

Other possibilities to lower risk is to benefit from SDS systems, which depend on the angle of the riser. This way there is another barrier to secure the well and avoid blowouts, without taking to account the DPO and the environmental factors having a bad influence on the reliability of the DPO.

To increase drills on board the DP vessel will probably prepare the crew better for real situations of LOP.

A suggestion to enhance the reliability of the DPO is to do independent QRAs of each operator under different types of working conditions. This can be difficult to perform, especially since knowledge, skills, experience and other personal skills of each operator needs to be mapped out in addition to the environmental risk factors.

A certificate to operate in Arctic waters can be provided to DPOs going through a program which specifically takes Arctic influencing factors into account and simulator training with likely events for the location the DPO is supposed to work in.

Other state-of-the-art methods may also be applicable for decreasing the probability for LOP incidents, as well as for the probability for blowout if it is not possible to retrieve position.

## Chapter 6

# Conclusion and Further Work

### 6.1 Conclusion

The results show that the more undesirable influencing factors, the less will the reliability of human operators be. In this case, this resulted in the DP drilling operation to be possess higher risk than without these factors. It can also be concluded that QRA techniques have numerous uses, and the manner they were applied in this thesis is a start. Nevertheless, there is a lot more work in validating the model as it would need real data to be effective in analyzing real cases. Another interesting fact which was examined in Chapter 3 is that Arctic cannot be seen as one area with one harsh climate. There are found similarities in the North Sea on some aspects for one place in the Arctic, but it can again be found to be very dissimilar at another Arctic location.

### 6.2 Future Work

To further analyze the impact of the environmental basic events found in the FTA leading to DPO error, and possibly quantify these effects, it would provide a better basis for performing a QRA and locating risk-reducing measures.

Note that implications might occur between wellhead and other DP vessels than MODUs as well. This was the case when an offshore supply vessels (OSV) had a LOP incident at the U.S. outer continental shelf while it was attached to the wellhead, which resulted in damage on the wellhead tree and

release of lubricants on the platform deck. Here, the joint report from the US Coast Guard and the Bureau of Safety and Environmental Enforcement (BSEE) revealed that the recommended guidance from the Marine Technology Society (MTS) for DP operations had not been followed. It was among other things found that the OSV only had a DP-1 equipment class, which means that a single failure can result in LOP. Also, the OSV did not have an Activity Specific Operating Guideline (ASOG) which prescribes emergency disconnect procedures as well as capability to prevent equipment damage and pollution [Bureau of Safety and Environmental Enforcement (BSEE), 2015]. This means that to only analyze with regards to releases of hydrocarbons and drilling muds is not sufficient. One would have to calculate for the possibility of crashing into surrounding vessels and installations as well.

For a more accurate analysis of DP drilling operations in the Arctic offshore, the barriers and events related more specifically towards the drilling operation needs to be assessed. These are not discussed in this thesis as the scope was to apply the QRA techniques towards the DP system.

To sum up, a future QRA about this subject should include the possibility for crashing into other installations, other barriers needs to be examined further and calculation of environmental loads should be conducted. Nevertheless, there is a need for operational experience in the Arctic offshore with continuous reporting of both accidents, near miss and events which could lead to accidents to get a more comprehensive data set for a analysts to investigate.

# Bibliography

- Allara, P. Information from personal inquiry, May 2015.
- American Meteorological Society, . snow, July 2013. URL <http://glossary.ametsoc.org/wiki/Snow>.
- Andersen, I. Slik bor offshorearbeiderne på Norges største boligrigg. online, April 2015. URL <http://www.tu.no/petroleum/2015/04/23/slik-bor-offshorearbeiderne-pa-norges-storste-boligrigg>.
- Aven, T. *Quantitative risk assessment: the scientific platform*. Cambridge University Press, March 2011. ISBN 9780521760577.
- Aven, T., Røed, W., and Wiencke, H.S. *Risikoanalyse*. Universitetsforlaget, 2nd edition, 2010. ISBN 978-82-15-01185-1.
- Bai, Y. *Marine Structural Design*. Elsevier Science Ltd, The Boulevard, Langford Lane, Kidlington, Oxford OX5 1GB, UK, 1st edition, 2003. ISBN 0-08-043921-7.
- Bureau of Safety and Environmental Enforcement (BSEE), . Safety alert #315: dynamic positioning system failures on offshore supply vessels engaged in oil and gas operations in the U.S. outer continental shelf. Safety alert 315, BSEE, February 2015. URL [http://www.bsee.gov/uploadedFiles/BSEE/Regulations/Safety\\_Alerts/FINAL%20USCG-BSEE%20Joint%20DP%20Safety%20Alert.pdf](http://www.bsee.gov/uploadedFiles/BSEE/Regulations/Safety_Alerts/FINAL%20USCG-BSEE%20Joint%20DP%20Safety%20Alert.pdf).
- Chen, H., Moan, T., and Verhoeven, H. Safety of dynamic positioning operations on mobile offshore drilling units. *Reliability Engineering and System Safety* 93, 93:1072–1090, 2008.
- DNV GL, Det Norske Veritas Germanische Lloyd. Offshore Standard DNV-OS-E301: Position Mooring. Offshore standard, DNV GL, October 2010a.
- DNV GL, Det Norske Veritas Germanische Lloyd. DNV-RP-G101 Risk Based Inspection of Offshore Topsides Static Mechanical Equipment. Recommended practice, Det Norske Veritas Germanische Lloyd DNV GL, October 2010b.

- DNV GL, Det Norske Veritas Germanische Lloyd. OLF/NOFO - Summary of differences between offshore drilling regulations in Norway and U.S. Gulf of Mexico. Report, Oljeindustriens Landsforening/Norsk Oljevernforening For Operatørselskap, August 2010c. URL <https://www.norskoljeoggass.no/PageFiles/6754/Report%20no%202010-1220%20Summary%20of%20differences%20REV%2002%202010-08-27%20signed.pdf>.
- DNV GL, Det Norske Veritas Germanische Lloyd. *DNV-RP-E307 Dynamic Positioning Systems - Operation Guidance*, January 2011.
- DNV GL, Det Norske Veritas Germanische Lloyd. Dynamic Positioning Vessel Design Philosophy Guidelines. Recommended practice, DNV GL, September 2012.
- DNV GL, Det Norske Veritas Germanische Lloyd. Appendix 3 Safety Risk HAZID Workshop. Technical report, DNV GL, October 2013.
- DNV GL, Det Norske Veritas Germanische Lloyd. Dynamic Positioning Systems. Rules for Classification of Ships, DNV GL, July 2014.
- DNV GL, Det Norske Veritas Germanische Lloyd. The arctic risk map, 2015a. URL <http://gis.dnv.com/arcticriskmap/>. Retrieved through DNV GL's website.
- DNV GL, Det Norske Veritas Germanische Lloyd. Hull Structural Design, Ships with Length 100 metres and above. Classification Rules, DNV GL, January 2015b.
- DNV GL, Det Norske Veritas Germanische Lloyd. The Arctic risk map, February 2015c. URL <http://gis.dnv.com/arcticriskmap/>.
- Fagerlid, G. O. Kva er egentleg dis?, November 2013. URL [http://www.yr.no/artikkel/kva-er-eigentleg-dis\\_-1.11345512](http://www.yr.no/artikkel/kva-er-eigentleg-dis_-1.11345512).
- Fox, K.C. Solar Cycle Primer, October 2011. URL [http://www.nasa.gov/mission\\_pages/sunearth/news/solarcycle-primer.html](http://www.nasa.gov/mission_pages/sunearth/news/solarcycle-primer.html).
- Fridtjof Nansen Institute and DNV, . Arctic Resource Development: Risks and Responsible Management. Fridtjof Nansen Institute, August 2012. URL <http://www.fni.no/doc&pdf/ONS-Arctic.pdf>.
- Germanischer Lloyd, . Hazard Identification Studies (HAZID). Online, May 2008. URL [http://www.germanlloyd.org/pdf/Hazard\\_Identification\\_Studies.pdf](http://www.germanlloyd.org/pdf/Hazard_Identification_Studies.pdf).



- Hauff, K.S. Analysis of Loss of Position Incidents for Dynamically Operated Vehicles. Master's thesis, Norwegian University of Science and Technology, June 2014. URL <http://www.diva-portal.org/smash/get/diva2:750221/FULLTEXT01.pdf>.
- Ibrahim, R. A. and Grace, I. M. Modeling of Ship Roll Dynamics and Its Coupling with Heave and Pitch. 2010. doi: 10.1155/2010/934714.
- IMCA - The International Marine Contractors Association, . IMCA M 117 - The Training and Experience of Key DP Personnel. Guideline, IMCA - The International Marine Contractors Association, January 1996. URL <http://s08.static-shell.com/content/dam/shell-new/local/country/bra/downloads/suppliers/tender-pslv/appendix-5-imcam117.pdf>.
- Jenssen, N.A. Mitigating Excessive Pitch and Roll Motions on Semi-Submersibles. Kongsberg Maritime AS, Dynamic Positioning Conference, October 2010.
- Kongsberg Maritime, . Dynamic positioning - DP systems. URL <http://www.km.kongsberg.com/ks/web/nokbg0240.nsf/AllWeb/14E17775E088ADC2C1256A4700319B04?OpenDocument>.
- Maersk Drilling , . Maersk inspirer. Technical report, Maersk Drilling, Maersk Drilling 50, Esplanaden, 1098 Copenhagen K, Denmark, October 2014. Information brochure.
- Markeset, T. Operations and maintenance in arctic, August 2013. Lecture notes.
- Meteorologisk institutt, . Mørketid, November 2009. URL <http://met.no/?module=Articles;action=Article.publicShow;ID=1494>.
- Moslet, P. O. Arctic Resource Development, August 2014. Presentation to trainees.
- National Oceanic and Atmospheric Administration, . Vessel Icing, December 2005. URL [http://www.vos.noaa.gov/MWL/dec\\_05/ves.shtml](http://www.vos.noaa.gov/MWL/dec_05/ves.shtml).
- National Oceanic and Atmospheric Administration, . Wind Chill, October 2012. URL <http://www.srh.noaa.gov/ama/?n=windchill>.
- Noer, G. The Polar Low pressure system, 2014. URL [http://www.dnvusa.com/industry/maritime/publicationsanddownloads/publications/updates/arctic/2009/01\\_2009/ThePolarLowpressuresystem.asp](http://www.dnvusa.com/industry/maritime/publicationsanddownloads/publications/updates/arctic/2009/01_2009/ThePolarLowpressuresystem.asp).
- Norsk Oljevernforening For Operatørselskap, . Bølgehøyde, 201Xa. URL <http://www.nofo.no/Plangrunnlag/Historiske-vardata/Bolgehoyde/>.

- Norsk Oljevernforening For Operatørselskap, . Vindstyrke, 201Xb. URL <http://www.nofo.no/Plangrunnlag/Historiske-vardata/Vindstyrke/>.
- O’Keefe, K., Stephen, J., Lachapelle, G., and Gonzales, R.A. Effect of Ice Loading of a GPS Antenna. In *Proceedings of the 1999 National Technical Meeting of The Institute of Navigation*, pages 861–869. The Institute of Navigation, January 1999.
- Okstad, K. A. Ekstremarbeid. *Univers*, (3):4–7, 2012. URL [http://issuu.com/univers/docs/univers\\_nr.\\_3\\_-\\_2012](http://issuu.com/univers/docs/univers_nr._3_-_2012).
- Overland, J. E. Prediction of Vessel Icing for Near-Freezing Sea Temperatures. *Weather and Forecasting*, 5:62–77, March 1990.
- Øvreberg, E. Kroppen forstår ikke at den er trøtt i mørketida, October 2012. URL [http://uit.no/nyheter/artikkel?p\\_document\\_id=318168](http://uit.no/nyheter/artikkel?p_document_id=318168).
- Paulsen, J.E., Hansen, O., and Bjørnbom, E. Søknad om tillatelse til virksomhet etter forurensningsloven for avgrensings- og produksjonsboring i PL 229 Goliat, June 2012. URL [http://www.eninorge.com/Documents/Rapporter/klif/ENINO\\_n2395030\\_v4\\_Eni\\_Norge\\_s%C3%B8knad\\_om\\_tillatelse\\_til\\_virksomhet\\_Goliat\\_produksjonsboring\\_PL229.pdf](http://www.eninorge.com/Documents/Rapporter/klif/ENINO_n2395030_v4_Eni_Norge_s%C3%B8knad_om_tillatelse_til_virksomhet_Goliat_produksjonsboring_PL229.pdf).
- Pedersen, K. Her skinner årets første midnattssol, April 2013. URL <http://www.yr.no/artikkel/arets-forste-bilde-av-midnattssola-1.11006711>.
- Petroleumstilsynet, . Risikonivå i petroleumsvirksomheten - Hovedrapport, utviklingstrekk 2013, norsk sokkel. Online, April 2014. URL [http://www.ptil.no/getfile.php/PDF/RNNP\\_2013/RNNP2013\\_hovedrapport.pdf](http://www.ptil.no/getfile.php/PDF/RNNP_2013/RNNP2013_hovedrapport.pdf).
- Rinnan, A. Arctic satellite navigation – lessons learned and new opportunities. Kongsberg SEATEX, November 2012. Presentation.
- Saipem S.p.A., . Scarabeo 8. Brochure, February 2013.
- Schlumberger Limited, SLB, . Dynamic positioning, 2015. URL <http://www.glossary.oilfield.slb.com/en/Terms.aspx?LookIn=term%20name&filter=dynamic+positioning>. Definition courtesy of Schlumberger Limited, used with permission.
- Shi, X.B., Philips, D., and Martinez, D. Case Study of DP Vessels Performing SIMOPS. American Global Maritime, Dynamic Positioning Committee, November 2005.
- Sondalini, M. *Plant and equipment wellness: a process for exceptional equipment reliability*. Engineers Media, 2 Ernest Place, Crows Nest, NSW 2065, 2009. ISBN 9780858255289.

- Sorensen, L.J., Øvergård, K.I., and Martinsen, T.J.S. Understanding Human Decision Making During Critical Incidents in Dynamic Positioning. In Sharples, Sarah and Shorrock, Steven T., editors, *Proceedings of the international conference on Ergonomics & Human Factors 2014*, page 359–366. Department of Maritime Technology and Innovation, Marine Human Factors Group, Vestfold University College, Taylor Francis, 2014. doi: 10.1201/b16742-64.
- Tangen, H. Arktisk vær og klima - betydningen for beredskap, June 2014. URL [https://www.norskoljeoggass.no/Global/HMS-utfordringer%20i%20nordomr%C3%A5dene/Seminar%205%20-%20Beredskap/0930%20Tangen%20Arbeidsseminar\\_5\\_Tangen\\_2014\\_V1.0.pdf](https://www.norskoljeoggass.no/Global/HMS-utfordringer%20i%20nordomr%C3%A5dene/Seminar%205%20-%20Beredskap/0930%20Tangen%20Arbeidsseminar_5_Tangen_2014_V1.0.pdf).
- Tangvold, T.B. Oljelasting fra Goliat. February 2010. Presentation.
- Committee, The Maritime Safety . Guidelines on Vessels With Dynamic Positioning Systems. Technical guideline IMO MSC/Circ. 645, International Maritime Organization, June 1994. URL <http://www.uscg.mil/hq/cg5/ocsncoe/docs/DP%20Guidance/IMO%20MSC%20Circ.645.pdf>.
- The Norwegian Government, . Foreløpig oppdatering av forvaltningsplanens iskant. Online press release, The Norwegian Government, January 2015. URL <https://www.regjeringen.no/contentassets/e1090e75b7a34ae7ad3894f9b9e5bc42/iskant.pdf>.
- Verhoeven, H., Chen, H., and T., Moan. Safety of Dynamic Positioning Operation on Mobile Offshore Drilling Units. Dynamic Positioning Conference, September 2004.
- Vinnem, J.E. *Offshore Risk Assessment: Principles, Modelling and Applications of QRA Studies*. Springer series in reliability engineering. Springer-Verlag London Limited, 2nd edition, 2007. ISBN 978-1-84628-716-9.
- Vitensenteret, . Nordlys, 2015. URL <http://nordnorsk.vitensenter.no/himmel/nordlys/fakta.php>.



## Appendix A

# Effect of wind on sea conditions

Table A.1: Effect of wind on wave height and sea state.

Beaufort scale	Wind speed		Description	Maximum wave height on a single wave Meter	Significant wave height for temporary wind Meter	Affection on sea
	knots	m/s				
-	< 1	0,0- 0,2	-	0	0	Sea like a mirror.
0			Calm			Ripples with the appearance of scales are formed, but without foam crests.
1	1-3	0,3-1,5	Light air	0,16	0,08	Small wavelets, still short but more pronounced, crests have a glassy appearance and do not break.
2	4-6	1,6-3,3	Light breeze	0,4	0,02	Large wavelets. Crests begin to break. Foam of glassy appearance.
3	7-10	3,4-5,4	Gentle breeze	1,2	0,6	Small waves, becoming longer.
4	11-16	5,5-7,9	Moderate breeze	2,2	1,1	Moderate waves, taking a more pronounced long form. (Chance of some spray).
5	17-21	8,0-10,7	Fresh breeze	3,6	1,8	Large waves begin to form; the white foam crests are more extensive everywhere. (Probably some spray).
6	22-27	10,8-13,8	Strong breeze	5,8	2,9	Sea heaps up and white foam from breaking waves begins to be blown in streaks along the direction of the wind.
7	28-33	13,9-17,1	Near gale	8,2	4,1	Moderately high waves of greater length; edges of crests begin to break into spindrift. The foam is blown in well marked streaks along the direction of the wind.
8	34-40	17,2-20,7	Gale	11	5,5	High waves. Dense streaks of foam along the direction of the wind. Crests of waves begin to topple, tumble and roll over. Spray may affect visibility.
9	41-47	20,8-24,4	Strong gale	14	7	Very high waves with long overhanging crests. The resulting foam in great patches is blown in dense white streaks along the direction of the wind. On the whole the surface of the sea takes a white appearance. Visibility affected.
10	48-55	24,5-28,4	Storm	17,8	8,9	Exceptionally high waves. (Small and medium sized ships might be for a time lost to view behind the waves.) The sea is completely covered with long white patches of foam lying along the direction of the wind. Everywhere the edges of the wave crests are blown into froth. Visibility affected.
11	56-63	28,5-32,6	Violent storm	22,6	11,3	The air is filled with foam and spray. Sea completely white with driving spray; visibility very seriously affected.
12	> 63	32,6-	Hurricane	27,4	13,7	